

**SONY**<sup>®</sup>

2-025-243-11(1)

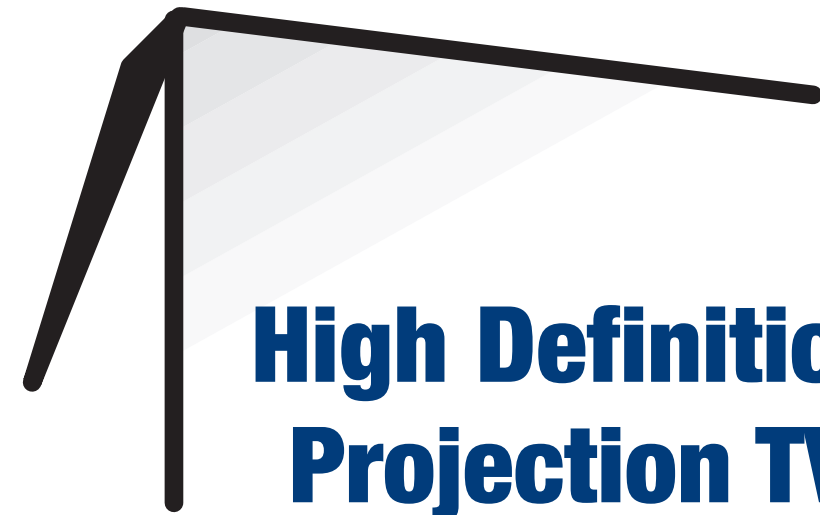

# High Definition Projection TV

Operating Instructions

© 2004 Sony Corporation

## Owner's Record

The model and serial numbers are located at the rear of the projection TV, below the Sony logo, on the sticker, and also on the TV box (white label). Record these numbers in the spaces provided below. Refer to them whenever you call upon your Sony dealer regarding this product.

Model No. \_\_\_\_\_

Serial No. \_\_\_\_\_

## WARNING

To reduce the risk of fire or electric shock, do not expose this apparatus to rain or moisture.

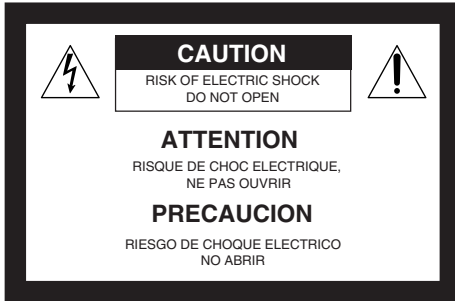

This symbol is intended to alert the user to the presence of uninsulated "dangerous voltage" within the product's enclosure that may be of sufficient magnitude to constitute a risk of electric shock to persons.



This symbol is intended to alert the user to the presence of important operating and maintenance (servicing) instructions in the literature accompanying the appliance.

Do not expose the TV to dripping or splashing. Avoid placing liquid-filled objects, such as vases, on top of the TV.

## CAUTION

To prevent electric shock, do not use this polarized AC plug with an extension cord, receptacle or other outlet unless the blades can be fully inserted to prevent blade exposure.

## CAUTION

If a fixed (non-moving) pattern, such as a station logo, is left on the screen for long periods of time, especially at a high brightness or picture setting, the image can be permanently imprinted onto the screen. These types of imprints are known as "image retention."

## How to Reduce the Risk of "Image Retention" on the Screen

Please take the following steps to reduce the risk of causing image retention:

- When using video games, computers, and similar products with your projection TV, or viewing a TV station whose logo always stays on the screen, keep the Brightness and Picture functions at low settings. (See page 84 for instructions on adjusting Brightness and Picture settings.)
- View a variety of programming material. Changing the program material viewed reduces the possibility that a single image will become imprinted on the screens.
- This TV was designed primarily for viewing TV broadcasts in wide screen mode (16:9 aspect ratio). Therefore when viewing conventional (4:3) aspect ratio TV programs, select Wide Mode settings that fill the image on your screen. This will reduce the possibility of the gray sidebars becoming permanently imprinted.

Please see page 84 for instructions on adjusting picture settings. See pages 59-60 for information about using Wide Mode.

**IMAGE RETENTION IS NOT COVERED BY YOUR WARRANTY**

## Note

This digital television is capable of receiving analog basic, digital basic and digital premium cable television programming by direct connection to a cable system providing such programming. A security card provided by your cable operator is required to view encrypted digital programming. Certain advanced and interactive digital cable services such as video-on-demand, a cable operator's enhanced program guide and data-enhanced television services may require the use of a set-top box. For more information call your local cable operator.

This television also includes a QAM demodulator which should allow you to receive unscrambled digital cable television programming via subscription service to a cable service provider. Availability of digital cable television programming in your area depends on the type of programming and signal provided by your cable service provider.

## Note on Caption Vision

This television receiver provides display of television closed captioning in accordance with §15.119 of the FCC rules.

## Note on Convergence Adjustment

Before you use your projection TV, make sure to adjust convergence. For details, see “Adjusting the Convergence Automatically (Flash Focus)” on page 44.

Use of this television receiver for other than private viewing of programs broadcast on UHF or VHF or transmitted by cable companies for the use of the general public may require authorization from the broadcaster /cable company and/or program owner.

## NOTIFICATION

This equipment has been tested and found to comply with the limits for a Class B digital device, pursuant to Part 15 of the FCC Rules. These limits are designed to provide reasonable protection against harmful interference in a residential installation. This equipment generates, uses, and can radiate radio frequency energy and, if not installed and used in accordance with the instructions, may cause harmful interference with radio communications. However, there is no guarantee that interference will not occur in a particular installation. If this equipment does cause harmful interference to radio or television reception, which can be determined by turning the equipment off and on, the user is encouraged to try to correct the interference by one or more of the following measures:

- ❑ Reorient or relocate the receiving antenna.
- ❑ Increase the separation between the equipment and receiver.
- ❑ Connect the equipment into an outlet on a circuit different from that to which the receiver is connected.
- ❑ Consult the dealer or an experienced radio/TV technician for help.

You are cautioned that any changes or modifications not expressly approved in this manual could void your authority to operate this equipment.

## Safety

- ❑ Operate the projection TV only on 120 V AC.
- ❑ The plug is designed, for safety purposes, to fit into the wall outlet only one way. If you are unable to insert the plug fully into the outlet, contact your dealer.
- ❑ If any liquid or solid object should fall inside the cabinet, unplug the projection TV immediately and have it checked by qualified service personnel before operating it further.
- ❑ If you will not be using the projection TV for several days, disconnect the power by pulling the plug itself. Never pull on the cord.
- ❑ For details concerning safety precautions, see “Important Safety Instructions” on page 3.

## Installing

- ❑ To prevent internal heat buildup, do not block the ventilation openings.
- ❑ Do not install the projection TV in a hot or humid place, or in a place subject to excessive dust or mechanical vibration.
- ❑ Avoid operating the projection TV at temperatures below 5°C (41°F).
- ❑ If the projection TV is transported directly from a cold to a warm location, or if the room temperature changes suddenly, the picture may be blurred or show poor color due to moisture condensation. In this case, please wait a few hours to let the moisture evaporate before turning on the projection TV.

- ❑ To obtain the best picture, do not expose the screen to direct illumination or direct sunlight. It is recommended to use spot lighting directed down from the ceiling or to cover the windows that face the screen with opaque drapery. It is desirable to install the projection TV in a room where the floor and walls are not of a reflective material.

## Trademark Information

TruSurround, SRS and the (●)\* symbol are trademarks of SRS Labs, Inc. TruSurround technology is incorporated under license from SRS Labs, Inc.



Manufactured under license from Dolby Laboratories. “Dolby” and the double-D symbol are trademarks of Dolby Laboratories.

Licensed by BBE Sound, Inc. under USP4638258, 4482866. “BBE” and BBE symbol are trademarks of BBE Sound, Inc.



This TV incorporates High-Definition Multimedia Interface (HDMI™) technology. HDMI, the HDMI logo and High-Definition Multimedia Interface are trademarks or registered trademarks of HDMI Licensing LLC.

CableCARD™ is a trademark of Cable Television Laboratories, Inc. Steady Sound, Digital Reality Creation, CineMotion, ClearEdge VM, HD Detailer, Memory Stick, Memory Stick Duo, Memory Stick PRO, Memory Stick PRO Duo, MagicGate, and Twin View are either trademarks or registered trademarks of Sony Corporation.

## For Safety

### Be careful when moving the projection TV

When you place the projection TV in position, be careful not to drop it on your foot or fingers.

Watch your footing while installing the projection TV.

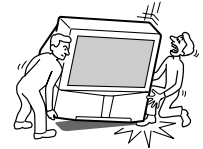

### Carry the projection TV in the specified manner

If you carry the projection TV in a manner other than the specified manner and without the specified number of persons, it may drop and a serious injury may be caused. Be sure to follow the instructions mentioned below.

- ❑ Carry the projection TV with the specified number of persons (see “Carrying Your Projection TV” on page 12).
- ❑ Do not carry the projection TV holding the speaker grill.
- ❑ Hold the projection TV tightly when carrying it.

# Important Safety Instructions

- 1 Read these instructions.
- 2 Keep these instructions.
- 3 Heed all warnings.
- 4 Follow all instructions.
- 5 Do not use this apparatus near water.
- 6 Clean only with dry cloth.
- 7 Do not block any ventilation openings. Install in accordance with the manufacturer's instructions.
- 8 Do not install near any heat sources such as radiators, heat registers, stoves, or other apparatus (including amplifiers) that produce heat.
- 9 Do not defeat the safety purpose of the polarized or grounding-type plug. A polarized plug has two blades with one wider than the other. A grounding type plug has two blades and a third grounding prong. The wide blade or the third prong are provided for your safety. If the provided plug does not fit into your outlet, consult an electrician for replacement of the obsolete outlet.
- 10 Protect the power cord from being walked on or pinched particularly at plugs, convenience receptacles, and the point where they exit from the apparatus.
- 11 Only use attachments/accessories specified by the manufacturer.
- 12 Use only with the cart, stand, tripod, bracket, or table specified by the manufacturer, or sold with the apparatus. When a cart is used, use caution when moving the cart/apparatus combination to avoid injury from tip-over.
- 13 Unplug this apparatus during lightning storms or when unused for long periods of time.
- 14 Refer all servicing to qualified service personnel. Servicing is required when the apparatus has been damaged in any way, such as power-supply cord or plug is damaged, liquid has been spilled or objects have fallen into the apparatus, the apparatus has been exposed to rain or moisture, does not operate normally, or has been dropped.



## Additional Cleaning Instructions

Clean the cabinet of the projection TV with a dry, soft cloth. To clean the screen of your projection TV, please use only a clean, soft cloth lightly dampened with water. Stubborn stains such as fingerprints can be removed with a clean, soft cloth lightly dampened with a solution of mild soap and warm water. Never use alcohol or strong solvents (such as thinner, benzene, ammonia, or alcohol-based), or abrasive cleaning solutions to clean your TV screen.

If the picture becomes dark after using the projection TV for a long period of time, it may be necessary to clean the inside of the projection TV. Consult qualified service personnel.



# Contents

## **Introducing the Projection TV**

<b>Overview</b> .....	<b>9</b>
Package Contents.....	9
Features .....	9

## **Setting Up the TV**

<b>Overview</b> .....	<b>11</b>
<b>Carrying Your Projection TV</b> .....	<b>12</b>
<b>Positioning the TV</b> .....	<b>12</b>
<b>TV Controls and Connectors</b> .....	<b>13</b>
Front Video Inputs .....	13
<b>TV Controls and Connectors</b> .....	<b>14</b>
Front Panel .....	14
Rear Panel .....	15
<b>Basic Connections: Connecting a Cable or Antenna</b> .....	<b>17</b>
About Using CableCARD .....	17
Cable or Antenna Only .....	18
Cable and Antenna Only .....	19
Cable Box and Cable Only .....	20
Cable Box Only .....	21
<b>Connecting Optional Equipment</b> .....	<b>22</b>
Making Video Connections.....	23
About Using S VIDEO .....	23
VCR and Cable .....	24
VCR and Cable Box .....	26
Satellite Receiver.....	28
Satellite Receiver and VCR .....	30
DVD Player with Component Video Connectors.....	32
DVD Player with S VIDEO and Audio Connectors .....	34
Camcorder .....	35
Audio Receiver .....	36
DVI-Equipped Device .....	37
HDMI-Equipped Device .....	38
<b>Connecting a Device with an Optical IN Connector</b> .....	<b>39</b>
<b>Using the CONTROL S Feature</b> .....	<b>40</b>
<b>Using CableCARD</b> .....	<b>41</b>
About Using CableCARD .....	41
Activating CableCARD Service .....	41
Removing the CableCARD .....	42
<b>Setting Up the Channel List</b> .....	<b>43</b>
Using Initial Setup.....	43
<b>Adjusting the Convergence Automatically (Flash Focus)</b> .....	<b>44</b>
Notes on Flash Focus .....	44
<b>Adjusting the Convergence Manually</b> .....	<b>45</b>
Notes on Adjusting the Convergence Manually .....	46

## Using the Remote Control

<b>Overview</b> .....	<b>47</b>
<b>Inserting Batteries</b> .....	<b>47</b>
<b>Button Descriptions</b> .....	<b>48</b>
<b>Programming the Remote Control</b> .....	<b>50</b>
<b>Using Other Equipment with Your TV Remote Control</b> .....	<b>52</b>
All Equipment .....	52
Operating a VCR .....	52
Operating a Satellite Receiver .....	52
Operating a Cable Box .....	53
Operating a DVD Player .....	53
Using the F1 and F2 Buttons .....	53

## Using the Features

<b>Overview</b> .....	<b>55</b>
<b>Watching TV</b> .....	<b>56</b>
<b>Using the Program Guide</b> .....	<b>57</b>
Using Additional Program Guide Options .....	58
<b>Using Wide Mode</b> .....	<b>59</b>
<b>Using Twin View</b> .....	<b>61</b>
Displaying Twin Pictures .....	61
Factors Affecting Twin View .....	61
Activating the Picture .....	62
Changing the Picture Size .....	63
<b>Using Favorite Channels</b> .....	<b>64</b>
Using the Channel Menu .....	64
Using the Favorite Channels Guide .....	65
<b>Using the Freeze Function</b> .....	<b>66</b>

## Using the Memory Stick Viewer

<b>About Memory Stick</b> .....	<b>67</b>
Features .....	67
Memory Stick Compatibility .....	68
Memory Stick Functionality .....	68
File Compatibility .....	69
Trademark Information .....	69
<b>Inserting and Removing a Memory Stick</b> .....	<b>70</b>
Inserting a Memory Stick .....	70
Removing a Memory Stick .....	71
<b>Using the Memory Stick Index</b> .....	<b>72</b>
Using the Memory Stick Index .....	73
<b>Viewing Photos</b> .....	<b>74</b>
Photo Controls .....	74
Photo Menu Bar Options .....	75
Using Zoom and Pan .....	76
Using Rotate .....	76
<b>Playing Movies</b> .....	<b>77</b>
Movie Controls .....	77
Movie Menu Bar Options .....	78

<b>Memory Stick Index Menu Bar Options .....</b>	<b>79</b>
Slide Show Menu Options .....	79
Contents Menu Options .....	80
Memory Stick Menu .....	80
<b>Notes on Using Memory Stick Media .....</b>	<b>81</b>
About DCF File Names .....	81
Memory Stick Precautions.....	82

## **Using the Menus**

<b>Overview .....</b>	<b>83</b>
<b>Navigating Through Menus .....</b>	<b>83</b>
<b>Using the Video Menu .....</b>	<b>84</b>
<b>Using the Audio Menu .....</b>	<b>86</b>
<b>Using the Screen Menu .....</b>	<b>88</b>
<b>Using the Channel Menu.....</b>	<b>89</b>
<b>Using the Parent Menu.....</b>	<b>91</b>
<b>Using the Setup Menu.....</b>	<b>94</b>
<b>Using the Applications Menu.....</b>	<b>97</b>

## **Other Information**

<b>Overview .....</b>	<b>99</b>
<b>Glossary .....</b>	<b>100</b>
<b>Contacting Sony.....</b>	<b>101</b>
<b>Troubleshooting.....</b>	<b>101</b>
Remote Control .....	101
Channels .....	102
CableCARD .....	102
Memory Stick .....	103
Audio .....	104
Video .....	105
General .....	105
<b>Specifications .....</b>	<b>107</b>
Optional Accessories.....	108
<b>Index .....</b>	<b>109</b>





# Introducing the Projection TV

## Overview

This chapter describes the contents of the package in which the TV is shipped and provides an overview of the features of your projection TV.

---

### Package Contents

Along with your new projection TV, the package contains a remote control and two AA batteries. No additional cables are included. These items are all you need to set up and operate the projection TV in its basic configuration.

Most components (VCRs, DVD players, etc.) come with the necessary cables to connect them. If you want to set up a complex system, you may need to buy extra cables, connectors, etc. Be sure to have these on hand before you start to connect your system.

---

### Features

Some of the features that you will enjoy with your new TV include:

- ❑ **Built-in Digital Television Receiver:** You can watch digital television programs and enjoy the improved audio/video quality offered by these programs. With high-definition signal reception, you can watch TV signals broadcast in HDTV for the clearest possible broadcast picture.
- ❑ **CableCARD slot:** Provides cable subscribers with access to digitally encrypted cable channels — without the need for a set-top box — that will enable you to receive not only standard definition but also high definition television. The CableCARD, which is provided by your cable TV company, is inserted into the TV's rear panel CableCARD slot. After the service is activated with your cable TV company, the card replaces the need for a separate set-top box. (Check with your cable TV company about CableCARD service details, limitations, pricing, and availability. For more information about CableCARD in this manual, see pages 17 and 41.)
- ❑ **Wide Mode:** Enables you to resize the picture.

- ❑ **DRC® (Digital Reality Creation) Multifunction:** Unlike conventional line doublers, the DRC Multifunction feature replaces the signal's NTSC waveform with the near-HD equivalent, while doubling the number of vertical and horizontal lines. This results in four times the density for quality sources, such as DVD, satellite, and digital camcorders. The Video Menu allows you to select interlaced, progressive, or CineMotion™ output.
- ❑ **Twin View™:** Using the Multi-Image Driver (MIDX), Twin View allows you to watch two programs side by side, with the ability to zoom in one picture. You can watch pictures from two different sources (1080i, 720p, 480p, and 480i) simultaneously. (Only the left Twin View window can display 1080i, 720p, and 480p sources.)
- ❑ **Favorite Channels:** Allows you to select from 16 of your favorite channels.
- ❑ **ClearEdge VM™ Velocity Modulation:** Sharpens picture definition by enhancing vertical lines.
- ❑ **Steady Sound®:** Equalizes volume levels so there is consistent output between programs and commercials.
- ❑ **Memory Stick® Viewer:** Lets you watch digital photo (JPEG) and movie (MPEG1) files that are stored on Memory Stick media.
- ❑ **Component Video Inputs:** Offers the best video quality for DVD (480p, 480i), and digital set-top box (HD1080i, 720p) connections.
- ❑ **HD Detailer™:** Wideband video amplifier has a high bandwidth frequency rating, which allows it to send more video information to the screen, resulting in finer picture quality, especially for HD sources.
- ❑ **CineMotion™:** Reverse 3-2 pulldown processing provides optimal picture quality for film-based sources (media originally shot in 24 frames-per-second format).
- ❑ **Parental Control:** V-Chip technology allows parents to block unsuitable programming from younger viewers.
- ❑ **HDMI (High-Definition Multimedia Interface):** Provides an uncompressed, all-digital audio/video interface between this TV and any HDMI-equipped audio/video component, such as a set-top box, DVD player, and A/V receiver. HDMI supports enhanced, or high-definition video, plus two-channel digital audio.

# Setting Up the TV

## Overview

This chapter includes illustrated instructions for setting up your TV.

<i>Topic</i>	<i>Page(s)</i>
TV Controls and Connectors	14-16
Basic Connections: Connecting a Cable or Antenna	17-21
Connecting Optional Equipment	
VCR and Cable	24
VCR and Cable Box	26
Satellite Receiver	28
Satellite Receiver and VCR	30
DVD Player with Component Video Connectors	32
DVD Player with S VIDEO and Audio Connectors	34
Camcorder	35
Audio Receiver	36
DVI-Equipped Device	37
HDMI-Equipped Device	38
Connecting a Device with an Optical IN Connector	39
Using the CONTROL S Feature	40
Using CableCARD	41
Setting Up the Channel List	43
Adjusting the Convergence Automatically (Flash Focus)	44
Adjusting the Convergence Manually	45

## Carrying Your Projection TV

Carrying the TV requires four or more people.

Models KP-51/57WS655 provide casters. Be sure to move your projection TV using these casters.

## Positioning the TV

Setup

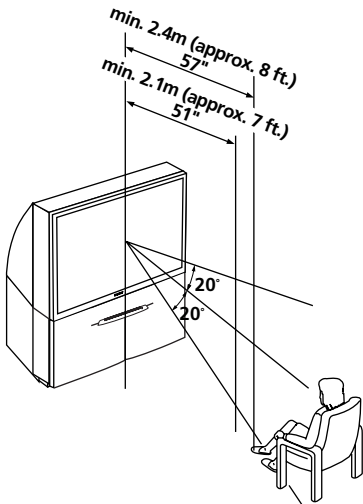

Recommended Vertical Viewing Angle

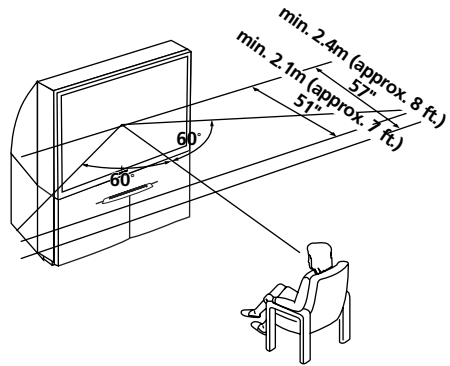

Recommended Horizontal Viewing Angle

## TV Controls and Connectors

Video inputs (Video 2) are provided on the front. To access, push up and release as shown.

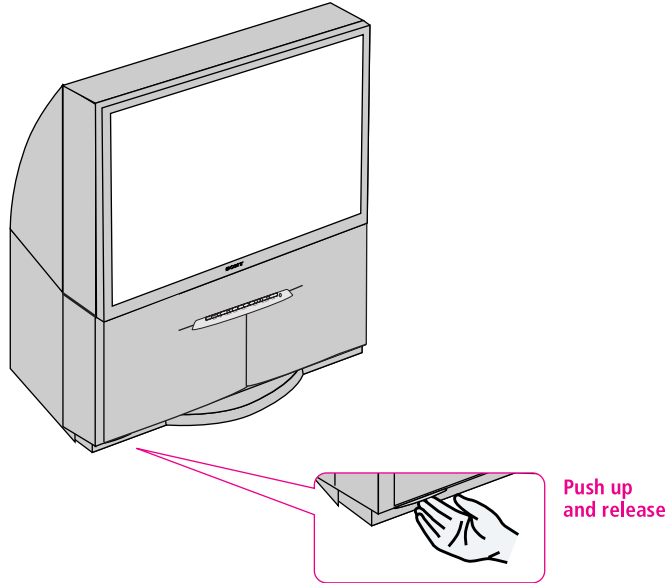

### Front Video Inputs

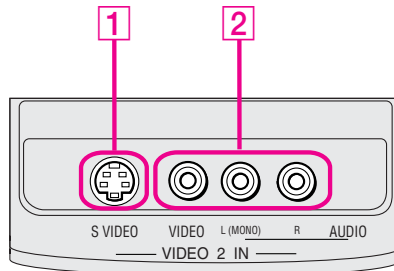

- |  |   |
|--|---|
| <p><b>1</b> S VIDEO<br/>VIDEO 2 INPUT</p>                    | <p>Connects to the S VIDEO OUT jack on your camcorder or other video equipment that has S VIDEO. Provides better picture quality than composite video (<b>2</b>).</p> |
| <p><b>2</b> VIDEO/L(MONO)-<br/>AUDIO-R<br/>VIDEO 2 INPUT</p> | <p>Connects to the composite A/V output jacks on your camcorder or other video equipment.</p>   |

# TV Controls and Connectors

## Front Panel

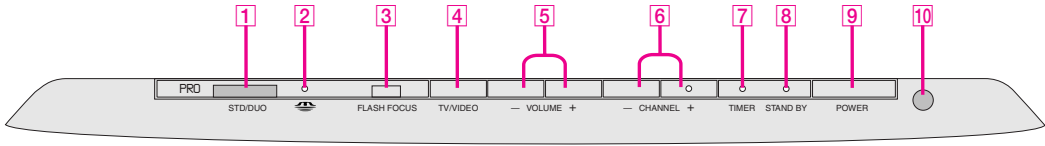

Item	Description
1 PRO STD/DUO 	Memory Stick insertion slot. For details, see “Inserting and Removing a Memory Stick” on page 70.
2 Memory Stick LED	When lit, indicates that the Memory Stick is being read. (Do not remove the Memory Stick when the indicator is lit.)
3 FLASH FOCUS	Press to adjust the convergence (see page 44).
4 TV/VIDEO	Press repeatedly to cycle through the video equipment connected to the TV’s video inputs.
5 -VOLUME +	Press to adjust the volume.
6 -CHANNEL+	Press to scan through channels. To scan quickly through channels, press and hold down either CHANNEL button.
7 TIMER LED	When lit, indicates one of the timers is set. When the timer is set, this LED will remain lit even if the TV is turned off. For details, see page 97.
8 STAND BY LED	Blinks when the TV is turned on, then shuts off when the picture is displayed. If the LED blinks continuously, this may indicate the TV needs service (see “Contacting Sony” on page 101).
9 POWER	Press to turn on and off the TV.
10 Infrared Receiver (IR)	Receives IR signals from the TV’s remote control.

## Rear Panel

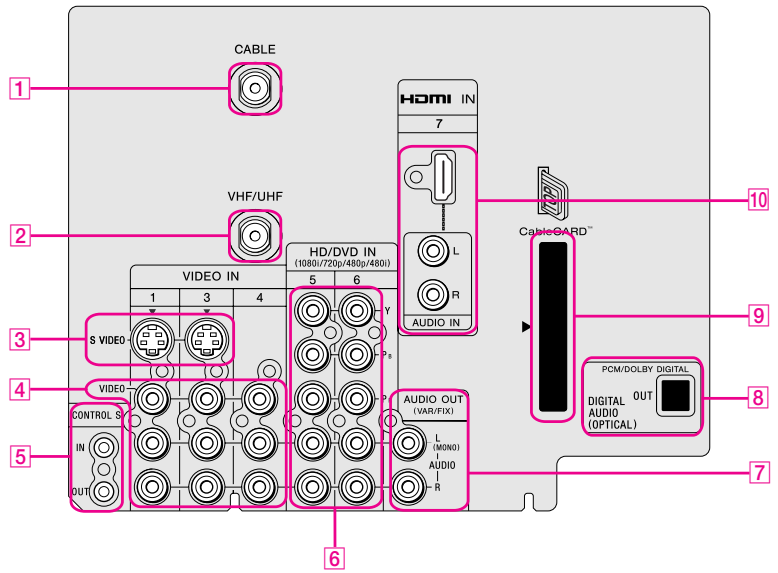



Jack	Description
<b>1</b> VHF/UHF	RF input that connects to your VHF/UHF antenna or cable box.
<b>2</b> Cable	RF input that connects to your cable signal.
<b>3</b> S VIDEO IN 1/3	Connects to the S VIDEO OUT jack of your VCR or other video equipment that has S VIDEO. S VIDEO provides better picture quality than either composite video ( <b>4</b> ) or VHF/UHF ( <b>1</b> ) connections.
<b>4</b> VIDEO IN 1/3/4 VIDEO/L(MONO) -AUDIO-R	Connect to the composite A/V output jacks on your VCR or other video component. A fourth component A/V input jack (VIDEO 2) is located on the front panel of the TV. This video connection provides better picture quality than the VHF/UHF ( <b>1</b> ) connection.
<b>5</b> CONTROL S IN/OUT	Allows the TV to receive (IN) and send (OUT) remote control signals to other Sony infrared-controlled audio or video equipment that has the CONTROL S function.
<b>6</b> HD/DVD IN 5/6 (1080i/720p/480p/480i)	Connect to your DVD player's or digital set-top box's component video (Y, PB, PR) and audio (L/R) jacks. Component video provides better picture quality than <b>1</b> , <b>3</b> , or <b>4</b> .
<b>7</b> AUDIO OUT (VAR/FIX)	Connects to the left and right audio input jacks of your audio or video equipment. You can use these outputs to listen to your TV's audio through your stereo system.
<b>8</b> DIGITAL AUDIO OPTICAL OUTPUT (DOLBY DIGITAL PCM)	Connect to the optical audio input of an audio component that is Dolby* Digital and PCM compatible.
<b>9</b> CableCARD Slot	Provides cable subscribers with access to digitally encrypted cable channels — without the need for a set-top box — that will enable you to receive not only standard definition but also high definition television. The CableCARD, which is provided by your cable TV company, is inserted into this slot. After the service is activated with your cable TV company, the card replaces the need for a separate set-top box. Check with your cable TV company about CableCARD service details, limitations, pricing, and availability. For more information, see page 41.
<b>10</b> HDMI (VIDEO 7 IN)	HDMI (High-Definition Multimedia Interface) provides an uncompressed, all-digital audio/video interface between this TV and any HDMI-equipped audio/video component, such as a set-top box, DVD player, and A/V receiver. HDMI supports enhanced, or high-definition video, plus two-channel digital audio.

\* "Dolby" and the double-D symbol are trademarks of Dolby Laboratories. Manufactured under license from Dolby Laboratories.

## Basic Connections: Connecting a Cable or Antenna

The way in which you will connect your TV varies, depending on how your home receives a signal (cable, cable box, antenna) and whether or not you plan to connect a VCR.

<b>If You Are Connecting</b>	<b>See Page</b>
<b>Cable or Antenna Only</b> <input type="checkbox"/> No cable box or VCR	18
<b>Cable and Antenna Only</b> <input type="checkbox"/> No cable box or VCR	19
<b>Cable Box and Cable Only</b> <input type="checkbox"/> Cable box unscrambles only some channels (usually premium channels) <input type="checkbox"/> No VCR	20
<b>Cable Box Only</b> <input type="checkbox"/> Cable box unscrambles all channels <input type="checkbox"/> No VCR	21

### **If you are connecting a VCR**

- See the connections described on pages 24 and 26.

### **About Using CableCARD**

If you are planning to use a separate cable box for digital cable TV services, you may be able to receive programming using this TV with the CableCARD instead — except in the following circumstances:

- Your cable TV company does not provide CableCARD service in your viewing area.
- You want to access your cable company's interactive or advanced features (such as video-on-demand or, in some cases, pay-per-view). At this time, these services require a bidirectional link, which are only available through the use of a separate set-top box. CableCARD is currently a unidirectional device only, and cannot provide these advanced services.

Check with your cable TV company for CableCARD service details, limitations, pricing, and availability, all of which are determined by your cable TV company — not Sony. For information on installing and activating CableCARD, see "Using CableCARD" on page 41.

## Cable or Antenna Only

For best results, use one of the following connections if you are connecting a cable or an antenna and you:

- ❑ Do not need a cable box to unscramble channels. (If you have a cable box, see pages 20-21.)
- ❑ Do not intend to connect a VCR. (If you have a VCR, see pages 24 and 26.)

The connection you choose depends on the cable type you have in your home, as described below.

### 75-ohm coaxial cable (usually found in newer homes)

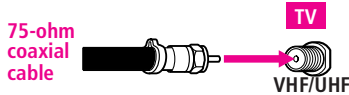
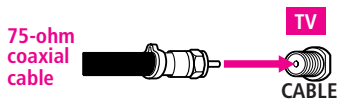
Cable Type	Connect As Shown
VHF Only or combined VHF/UHF	 <p>75-ohm coaxial cable</p> <p>TV</p> <p>VHF/UHF</p>
Cable	 <p>75-ohm coaxial cable</p> <p>TV</p> <p>CABLE</p>

### 300-ohm twin lead cable (usually found in older homes)

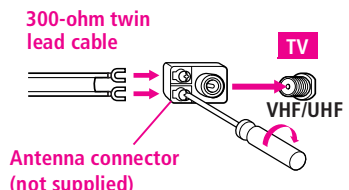
Cable Type	Connect As Shown
VHF Only or UHF Only or combined VHF/UHF	 <p>300-ohm twin lead cable</p> <p>TV</p> <p>VHF/UHF</p> <p>Antenna connector (not supplied)</p>

### 75-ohm coaxial and 300-ohm twin lead cable (found in some homes)

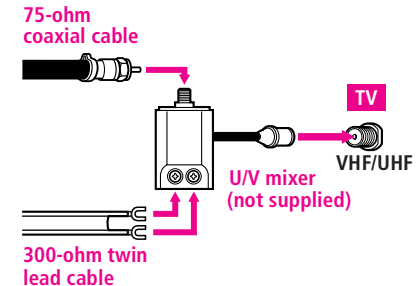
Cable Type	Connect As Shown
VHF and UHF	 <p>75-ohm coaxial cable</p> <p>TV</p> <p>VHF/UHF</p> <p>U/V mixer (not supplied)</p> <p>300-ohm twin lead cable</p>

## Cable and Antenna Only

### For best results, use this connection if you:

- ❑ Have a cable and an antenna.  
(This is convenient if you are using a separate rooftop antenna to receive additional channels that are not provided by your cable company.)
- ❑ Do not have a cable box or VCR. (If you have a cable box, see pages 20 to 21. If you have a VCR, see pages 24 and 26.)

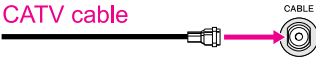
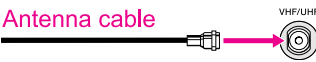
Cable Type	Connect As Shown
Cable TV (CATV) and Antenna	<p><b>CATV cable</b></p>  <p><b>Antenna cable</b></p> 

### Notes on Using This Connection

To Do This ...	Do This ...
Switch the TV's input between the cable and antenna	Press <b>ANT</b> to switch back and forth between the TV's VHF/UHF and CABLE inputs.

## Cable Box and Cable Only

Before connecting a cable box, see "About Using CableCARD" on page 17.

### For best results, use this connection if:

- ❑ Your cable company scrambles some channels, such as premium channels (which requires you to use a cable box), but does not scramble all channels.
- ❑ You do not have a VCR. (If you have a VCR, see pages 24 and 26.)

### With this connection you can:

- ❑ Use the TV remote control to change channels coming through the cable box to the TV's VHF/UHF input jack. (You must first program the remote control for your specific cable box; see "Programming the Remote Control" on page 50.)
- ❑ Use the TV remote control to change channels coming directly into the TV's CABLE input. (The TV's tuner provides a better signal than the cable box.)

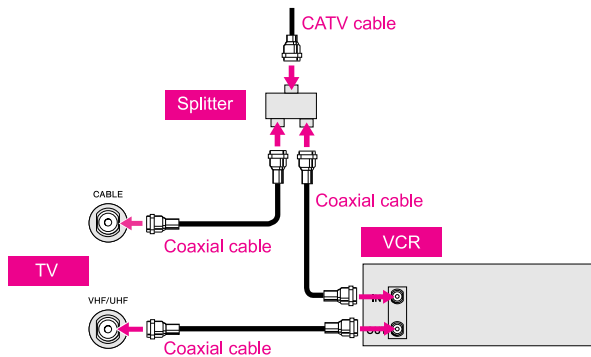

### Notes on Using This Connection

To Do This ...	Do This ...
Use the cable box	Tune the TV to the channel the cable box is set to (usually channel 3 or 4) and then use the cable box to switch channels.
Set up the TV remote control to operate the cable box	Program the remote control. See "Programming the Remote Control" on pages 50-51.
Activate the remote control to operate the cable box	Press <b>SAT/CABLE FUNCTION</b> .
Switch the TV's input between the cable box and cable	Press <b>ANT</b> to switch back and forth between the TV's VHF/UHF (scrambled channels) and CABLE (unscrambled) inputs.

## Cable Box Only

Before connecting a cable box, see "About Using CableCARD" on page 17.

### For best results, use this connection if:

- ❑ Your cable company scrambles all channels, which requires you to use a cable box.
- ❑ You do not have a VCR. (If you have a VCR, see pages 24 and 26.)

### With this connection you can:

- ❑ Use the TV remote control to change channels coming through the cable box to the TV's VHF/UHF jack. (You must first program the remote control for your specific cable box.)

### To connect the cable box

- 1 Connect the CATV cable to the cable box's input jack.
- 2 Use a coaxial cable to connect the cable box's output jack to the TV's VHF/UHF jack.

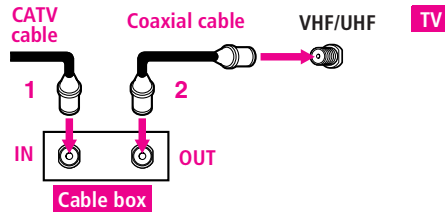

- 3 Run Auto Program, as described in "Setting Up the Channel List" on page 43.

### Notes on Using This Connection

To Do This ...	Do This ...
Use the cable box	Tune the TV to the channel the cable box is set to (usually channel 3 or 4) and then use the cable box to switch channels.
Set up the TV remote control to operate the cable box	Program the remote control. See "Programming the Remote Control" on pages 50.
Activate the remote control to operate the cable box	Press <b>SAT/CABLE FUNCTION</b> .

## Connecting Optional Equipment

Use the directions in this section to connect the following optional equipment:

<i>If You Are Connecting</i>	<i>See Page</i>
VCR and Cable	24
VCR and Cable Box	26
Satellite Receiver	28
Satellite Receiver and VCR	30
DVD Player with Component Video Connectors	32
DVD Player with S VIDEO and Audio Connectors	34
Camcorder	35
Audio Receiver	36
DVI-Equipped Device	37
HDMI-Equipped Device	38

## Making Video Connections

Your TV includes several types of video inputs. When connecting your TV, use the inputs that are available on your components that provide the best video performance, as described below.

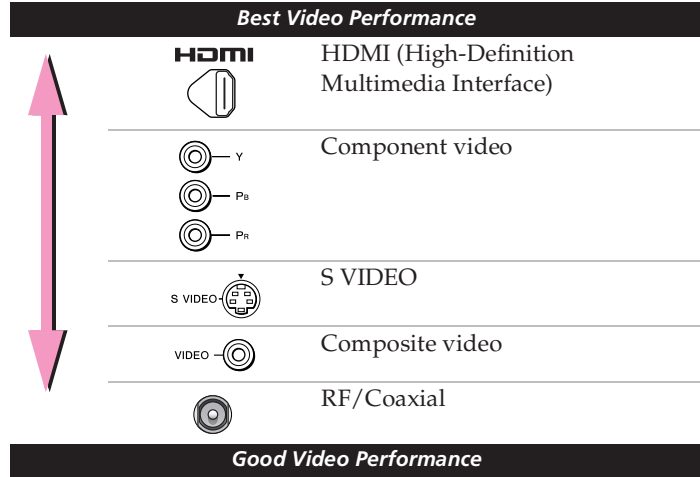

## About Using S VIDEO



If the optional equipment you are connecting has an S VIDEO jack (shown at left), you can use an S VIDEO cable for improved picture quality (compared to an A/V cable). Because S VIDEO carries only the video signal, you also need to connect audio cables for sound, as shown below.

### Example of an S VIDEO Connection

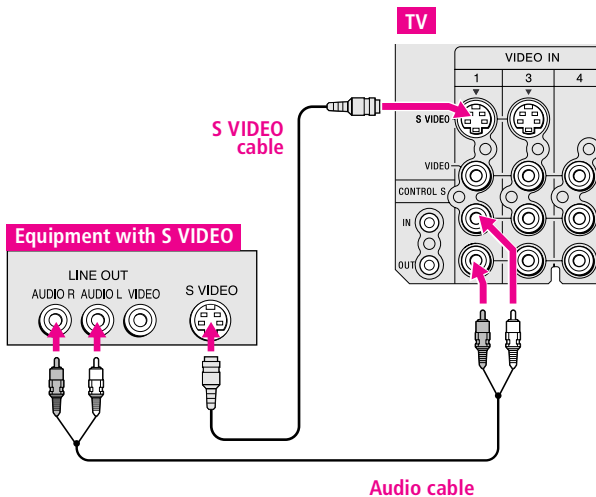

Cables are often color-coded to connectors. Connect red to red, white to white, etc.



## VCR and Cable



Using  
S VIDEO jacks?  
See page 23.

For best results, use this connection if:

- ❑ Your cable company does not require you to use a cable box.

To connect the VCR and cable

- 1 Connect the CATV cable to the VCR's VHF/UHF input jack.
- 2 Use a coaxial cable to connect the VCR's VHF/UHF output jack to the TV's CABLE jack.
- 3 Use an A/V cable to connect the VCR's A/V output jacks to the TV's A/V input jacks.
- 4 Run Auto Program, as described in "Setting Up the Channel List" on page 43.

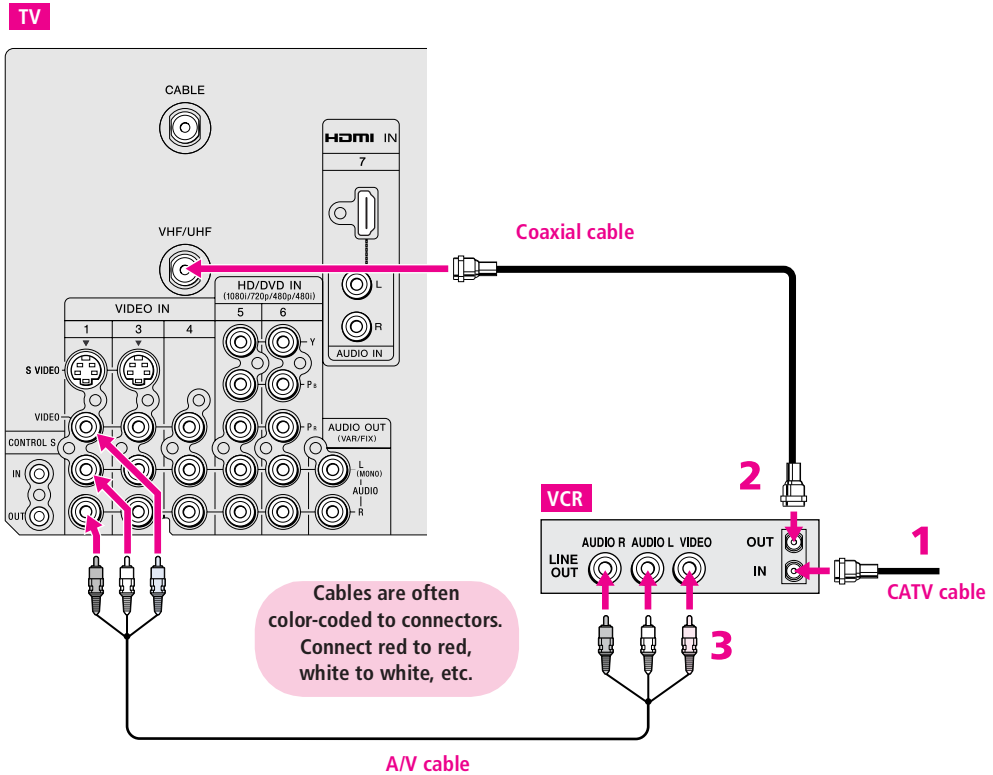

## Notes on Using This Connection

To Do This ...	Do This ...
Watch the VCR	Press <b>TV/VIDEO</b> repeatedly to select the VCR input (VIDEO 1 in the illustration).
Watch cable channels	Press <b>TV/VIDEO</b> repeatedly to select the cable input (CABLE in the illustration).
Set up the TV remote control to operate the VCR	If you have a non-Sony VCR, you must program the remote control. See “Programming the Remote Control” on pages 50-51.
Activate the TV remote control to operate the VCR	Press <b>DVD/VCR FUNCTION</b> .
Control VCR functions with the TV remote control	See “Operating a VCR” on page 52.
Label video inputs to easily identify equipment connected to the TV	See the instructions for setting up Video Labels on page 95.

## VCR and Cable Box

Before connecting a cable box, see “About Using CableCARD” on page 17.

### For best results, use this connection if:

- ❑ Your cable company scrambles some channels, such as premium channels (which requires you to use a cable box), but does not scramble all channels.

### With this connection you can:

- ❑ Use the TV remote control to change channels coming through the cable box. (You must first program the remote control for your specific cable box; see “Programming the Remote Control” on page 50.)
- ❑ Use the TV remote control to change channels coming directly into the TV’s CABLE jack. (The TV’s tuner provides a better signal than the cable box.)
- ❑ Record channels coming through the cable box and channels coming directly into the TV.

### To connect a VCR and cable box, you need:

- ❑ A splitter, which is a small, inexpensive device that you can purchase at your local electronics store.
- ❑ Four coaxial cables.
- ❑ Two A/V cables or two S VIDEO cable with audio cables.

### To connect the VCR and cable box

- 1 Connect the CATV cable to the single (input) jack of the splitter.
- 2 Use a coaxial cable to connect one of the splitter’s two output jacks to the TV’s CABLE jack.
- 3 Use a coaxial cable to connect the splitter’s other output jack to the cable box’s input jack.
- 4 Use a coaxial cable to connect the cable box’s output jack to the VCR’s RF input jack.
- 5 Use a coaxial cable to connect the VCR’s RF output jack to the TV’s VHF/UHF jack.
- 6 Use an A/V cable to connect the cable box’s A/V output jacks to the TV’s A/V input jacks.
- 7 Use an A/V cable to connect the VCR’s A/V output jacks to the TV’s A/V input jacks.
- 8 Run Auto Program, as described in “Setting Up the Channel List” on page 43.



Using  
S VIDEO jacks?  
See page 23.

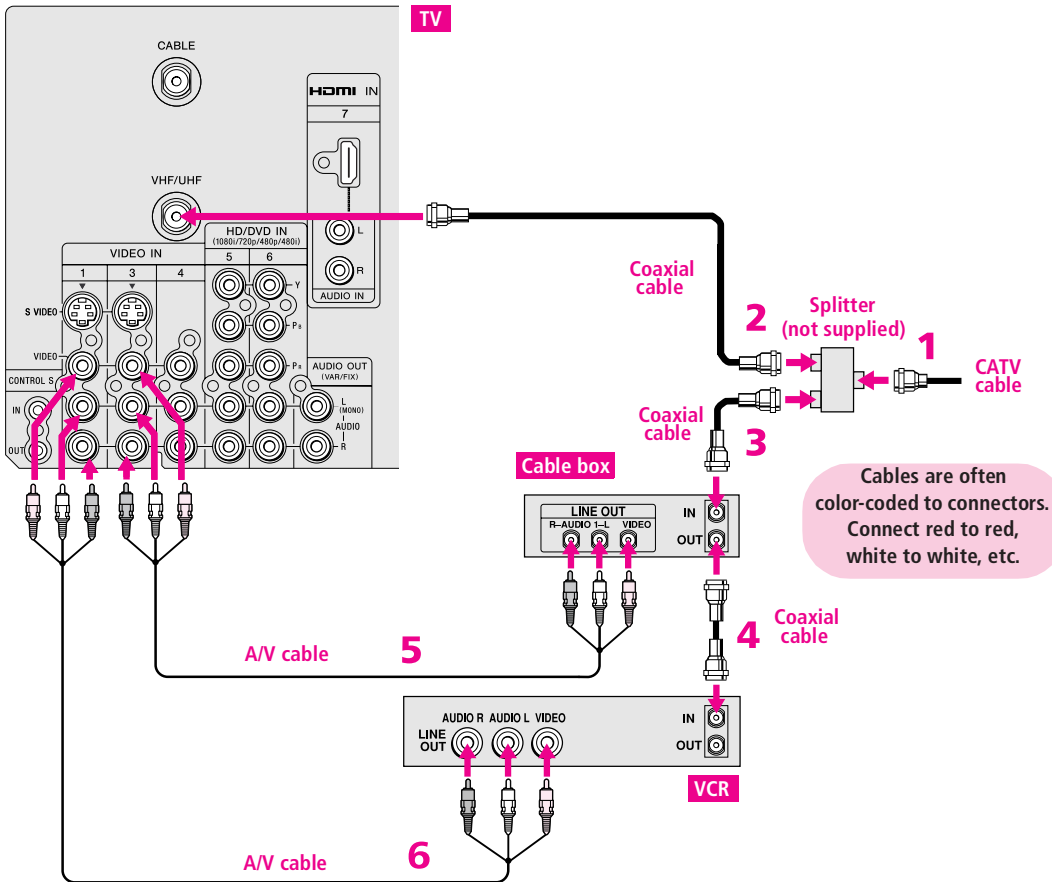

### Notes on Using This Connection

To Do This ...	Do This ...
Watch cable (unscrambled) channels	Press <b>TV/VIDEO</b> repeatedly to select the cable input (CABLE in the illustration).
Watch cable box (scrambled) channels	Press <b>TV/VIDEO</b> repeatedly to select the cable box input (VIDEO 3 in the illustration). Use the cable box to change channels.
Watch the VCR	Press <b>TV/VIDEO</b> repeatedly to select the VCR input (VIDEO 1 in the illustration).
Set up the TV remote control to operate the cable box or VCR	If you have a non-Sony VCR, you must program the remote control. See "Programming the Remote Control" on pages 50-51.
Activate the remote control to operate the cable box or VCR	For the cable box, press <b>SAT/CABLE FUNCTION</b> . For the VCR, press <b>DVD/VCR FUNCTION</b> .
Control specific cable box and VCR functions with the TV remote control	See "Operating a Cable Box" on page 53 and "Operating a VCR" on page 52.
Label video inputs to easily identify equipment connected to the TV	See the instructions for setting up Video Labels on page 95.

## Satellite Receiver



Using S VIDEO jacks?  
See page 23.

### To connect a satellite receiver

- 1 Connect the satellite antenna cable to the satellite receiver's satellite input jack.
- 2 Use an A/V cable to connect the satellite receiver's A/V output jacks to the TV's A/V input jacks.
- 3 Connect a CATV cable from your cable or antenna to the TV's CABLE jack.
- 4 Run Auto Program, as described in "Setting Up the Channel List" on page 43.

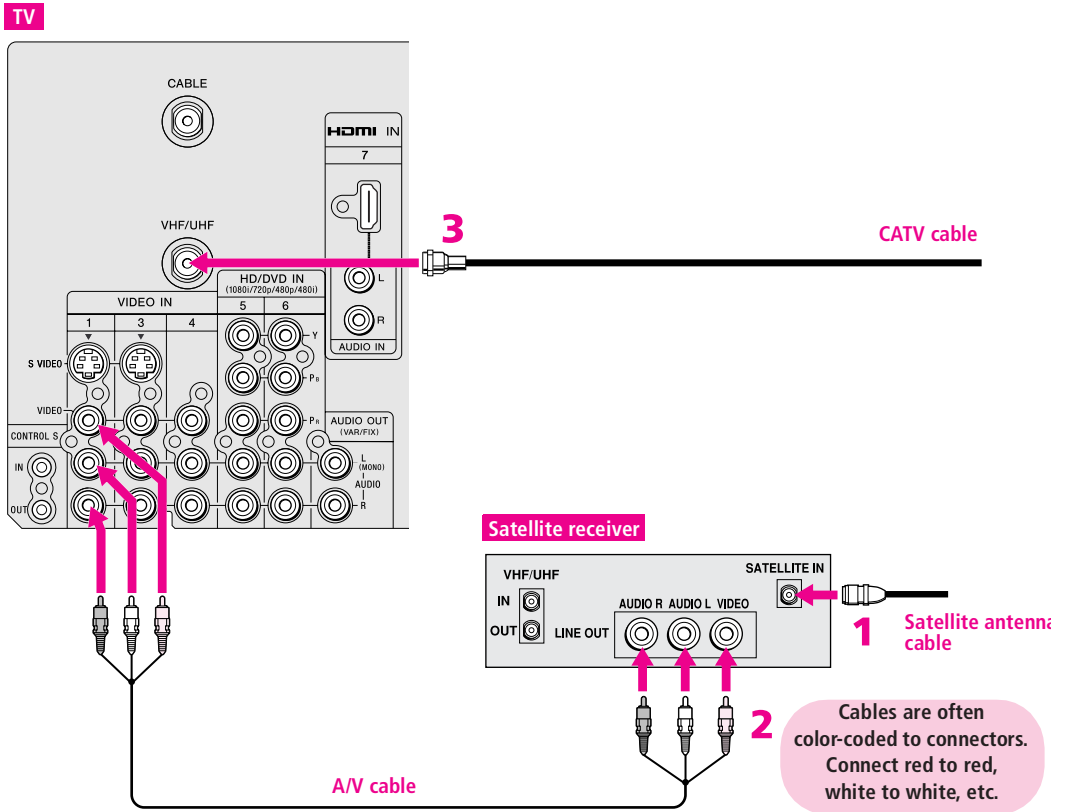

## Notes on Using This Connection

To Do This ...	Do This ...
Watch the satellite receiver	Press <b>TV/VIDEO</b> repeatedly to select the satellite receiver input (VIDEO 1 in the illustration).
Set up the TV remote control to operate the satellite receiver	If you have a non-Sony satellite receiver, you must program the remote control. See "Programming the Remote Control" on pages 50-51.
Activate the TV remote control to operate the satellite receiver	Press <b>SAT/CABLE FUNCTION</b> .
Control satellite receiver functions with the TV remote control	See "Operating a Satellite Receiver" on page 52.
Label video inputs to easily identify equipment connected to the TV	See the instructions for setting up Video Labels on page 95.

# Satellite Receiver and VCR



Using S VIDEO jacks? See page 23.

## To connect a satellite receiver and VCR

- 1 Connect the CATV cable to the single (input) jack of the splitter.
- 2 Use a coaxial cable to connect one of the splitter's two output jacks to the TV's CABLE jack.
- 3 Use a coaxial cable to connect the splitter's other output jack to the satellite receiver's VHF/UHF input jack.
- 4 Connect the satellite antenna cable to the satellite receiver's satellite input jack.
- 5 Use a coaxial cable to connect the satellite receiver's VHF/UHF output jack to the VCR's VHF/UHF input jack.
- 6 Use an A/V cable to connect the satellite receiver's A/V output jacks to the TV's A/V input jacks.
- 7 Use an A/V cable to connect the VCR's A/V output jacks to the TV's A/V input jacks.
- 8 Run Auto Program, as described in "Setting Up the Channel List" on page 43.

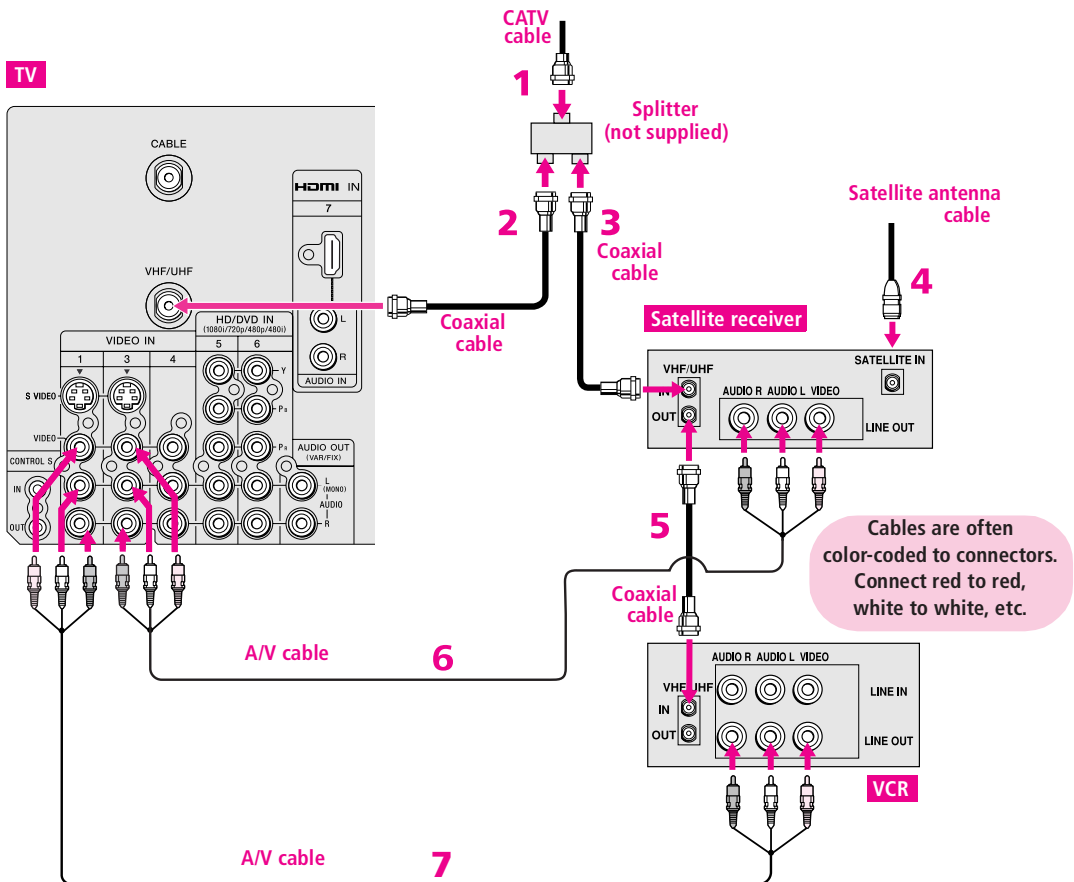

## Notes on Using This Connection

To Do This ...	Do This ...
Watch the satellite receiver	Press <b>TV/VIDEO</b> repeatedly to select the VCR input (VIDEO 3 in the illustration).
Watch the VCR	Press <b>TV/VIDEO</b> repeatedly to select the input to which the VCR is connected (VIDEO 1 in the illustration).
Set up the TV remote control to operate the satellite receiver or VCR	If you have a non-Sony VCR or satellite receiver, you must program the remote control. See "Programming the Remote Control" on pages 50-51.
Activate the TV remote control to operate the satellite receiver or VCR	For the satellite receiver, press <b>SAT/CABLE FUNCTION</b> . For the VCR, press <b>DVD/VCR FUNCTION</b> .
Control satellite receiver and VCR functions with the TV remote control	See "Operating a Satellite Receiver" on page 52 and "Operating a VCR" on page 52.
Label video inputs to easily identify equipment connected to the TV	See the instructions for setting up Video Labels on page 95.



## DVD Player with Component Video Connectors

For best results, use this connection if your DVD player has component video (Y, PB, PR) jacks.

### To connect a DVD player with component video connectors

- 1 Use three separate component video cables to connect the DVD player's Y, PB and PR jacks to the Y, PB and PR jacks (VIDEO 5) on the TV.

 The Y, PB and PR jacks on your DVD player are sometimes labeled Y, CB and CR, or Y, B-Y and R-Y. If so, connect the cables to like colors.

- 2 Use an audio cable to connect the DVD player's audio output jacks to the TV's VIDEO 5 audio input jacks.

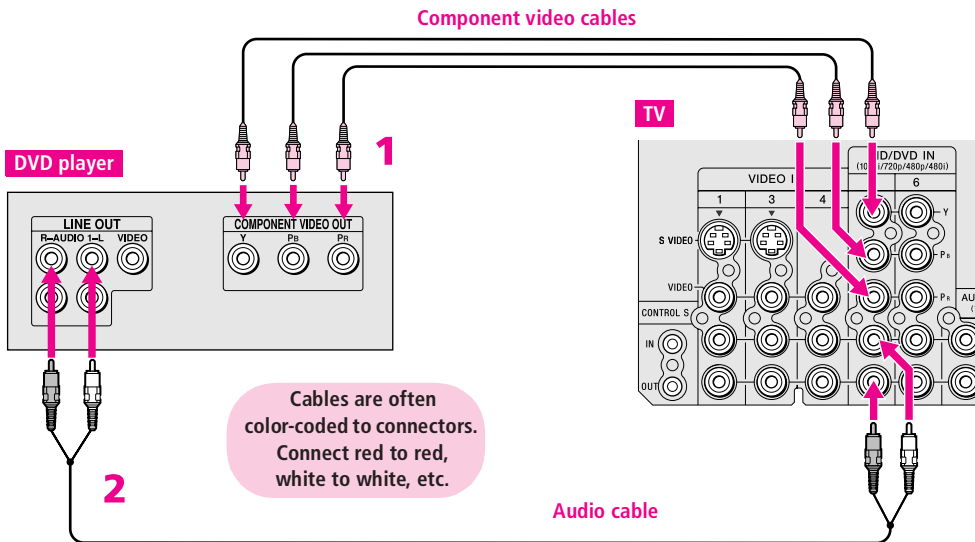

## Notes on Using This Connection

To Do This ...	Do This ...
Watch the DVD player	Press <b>TV/VIDEO</b> repeatedly to select the DVD input (VIDEO 5 in the illustration).
Set up the TV remote control to operate the DVD player	If you have a non-Sony DVD player, you must program the remote control. See "Programming the Remote Control" on pages 50-51.
Activate the TV remote control to operate the DVD player	Press <b>DVD/VCR FUNCTION</b> .
Control DVD functions with the TV remote control	See "Operating a DVD Player" on page 53.
Label video inputs to easily identify equipment connected to the TV	See the instructions for setting up Video Labels on page 95.

 **You cannot record the signal from any equipment connected into the Y, PB, PR jacks.**

## DVD Player with S VIDEO and Audio Connectors

Use this connection if your DVD player does not have component video (Y, PB, PR) jacks.

### To connect a DVD player with A/V connectors

- 1 Use an audio cable to connect the DVD player's audio output jacks to the TV's audio input jacks.
- 2 Use an S VIDEO cable to connect the DVD player's S VIDEO jack to the TV's S VIDEO jack.

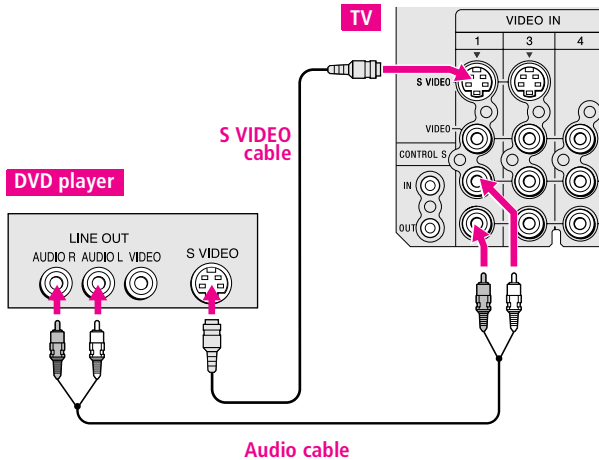

Cables are often color-coded to connectors. Connect red to red, white to white, etc.

### Notes on Using This Connection

To Do This ...	Do This ...
Watch the DVD player	Press <b>TV/VIDEO</b> repeatedly to select the DVD input (VIDEO 1 in the illustration).
Set up the TV remote control to operate the DVD player	If you have a non-Sony DVD player, you must program the remote control. See "Programming the Remote Control" on pages 50-51.
Activate the TV remote control to operate the DVD player	Press <b>DVD/VCR FUNCTION</b> .
Control DVD functions with the TV remote control	See "Operating a DVD Player" on page 53.
Label video inputs to easily identify equipment connected to the TV	See the instructions for setting up Video Labels on page 95.

## Camcorder



Using  
S VIDEO jacks?  
See page 23.

For easy connection of a camcorder, the TV has front A/V input jacks. If you prefer, however, you can connect the camcorder to the TV's rear A/V input jacks.

### To connect a camcorder

- 1 Use A/V cables to connect the camcorder's A/V output jacks to the TV's A/V input jacks.

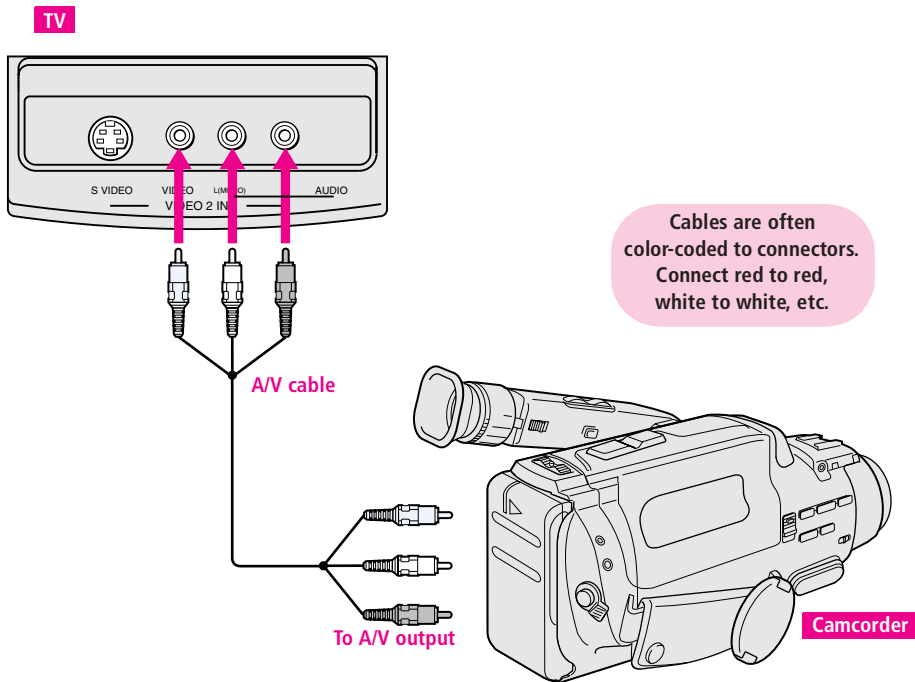

If you have a mono camcorder, connect its audio output jack to the TV's L MONO audio jack.

### Notes on Using This Connection

#### To Do This ...

Watch the camcorder

Label video inputs to easily identify equipment connected to the TV

#### Do This ...

Press **TV/VIDEO** repeatedly to select the camcorder input (VIDEO 2 in the illustration).

See the instructions for setting up Video Labels on page 95.

## Audio Receiver

For improved sound quality, you may want to play the TV's audio through your stereo system.

### To connect an audio system

- 1 Use an audio cable to connect the TV's audio output jacks to the audio receiver's line input jacks.

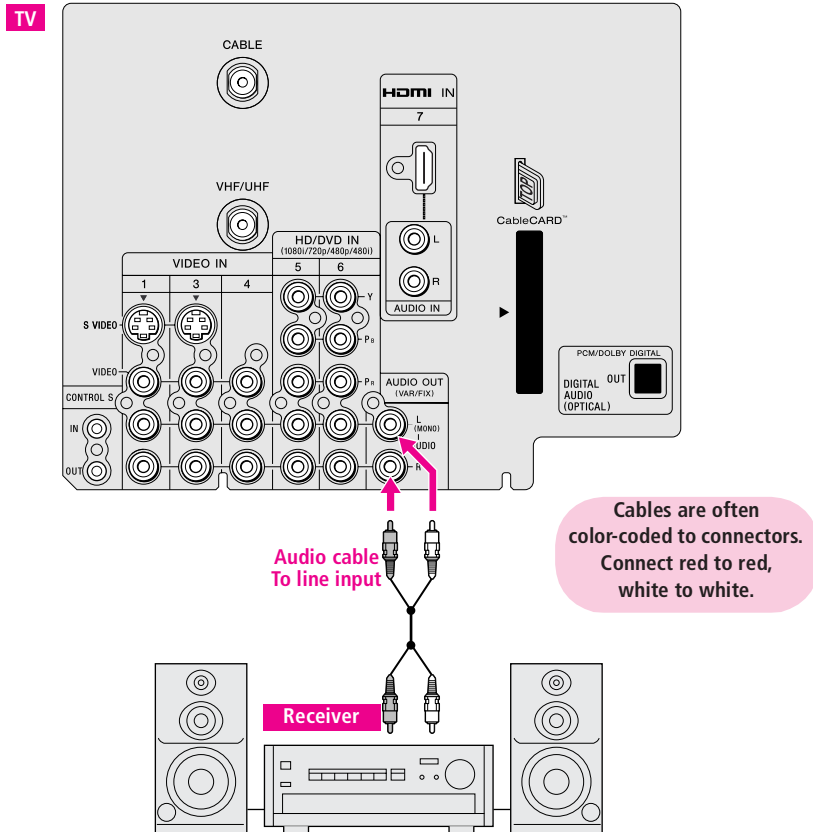

- 2 Using the TV's Audio Menu, set the **Speaker** option to **Off**. Then set the **Audio Out** option to **Fixed** or **Variable**, depending on how you want to control the volume. For details, see "Using the Audio Menu" on page 86.
- 3 Turn on the audio receiver, and then set the receiver's line input to the jack into which you connected the TV.

## DVI-Equipped Device

If you have a device, such as an HDTV receiver, that has DVI (Digital Video Interface) output, use the following connection.

### To connect a device that has DVI OUT:

- 1 Use an HDMI-to-DVI cable to connect the device's DVI OUT jack to the TV's HDMI IN jack.

 You can purchase HDMI cables (or cable adapters) at your local electronics store.

- 2 Use an audio cable to connect the device's audio output jacks to the TV's HDMI analog audio input jacks.

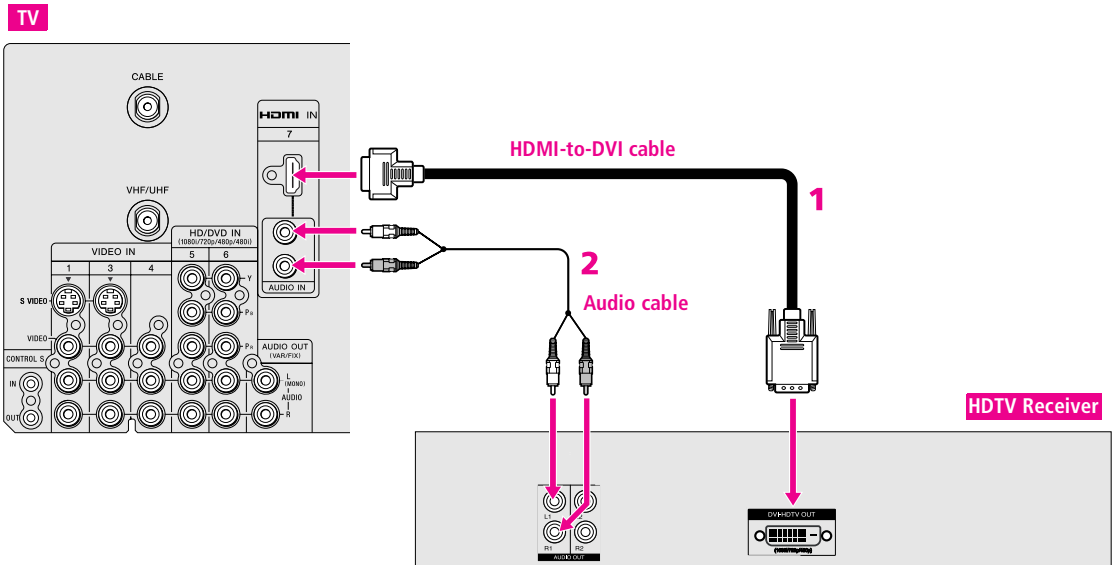

### Note on Using This Connection

To Do This ...	Do This ...
Watch the DVI device	Press <b>TV/VIDEO</b> repeatedly to select the VIDEO 7 input.
Label video inputs to easily identify equipment connected to the TV	See the instructions for setting up Video Labels on page 95.

## HDMI-Equipped Device

If you have a device, such as an HDTV receiver, that has a High-Definition Multimedia Interface (HDMI), use the following connection.

### To connect a device that has HDMI OUT:

- 1 Use the HDMI cable that came with your device to connect the device's HDMI OUT jack to the TV's HDMI IN jack.

 HDMI cables transmit both audio and video signals. (Separate audio cables are not necessary.) You can purchase HDMI cables at your local electronics store.

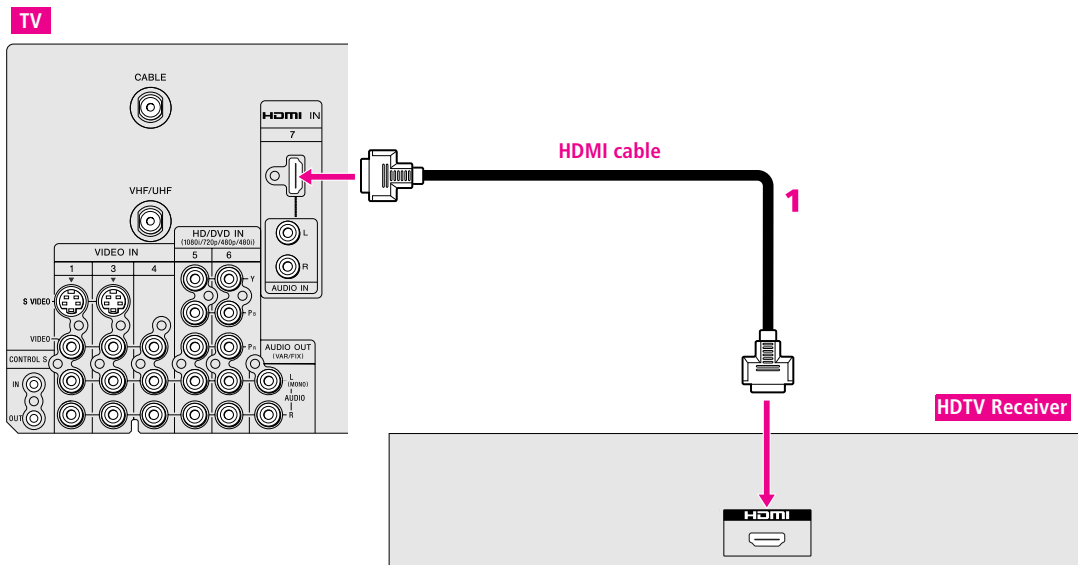

### Note on Using This Connection

To Do This ...	Do This ...
Watch the HDMI device	Press <b>TV/VIDEO</b> repeatedly to select the VIDEO 7 input.
Label video inputs to easily identify equipment connected to the TV	See the instructions for setting up Video Labels on page 95.

## Connecting a Device with an Optical IN Connector

You can use the TV's DIGITAL AUDIO OPTICAL output jack to connect an audio device that is Dolby Digital and PCM compatible, such as an audio amplifier.

- Using an optical cable, connect the TV's DIGITAL AUDIO OPTICAL output jack to the device's audio optical input jack.

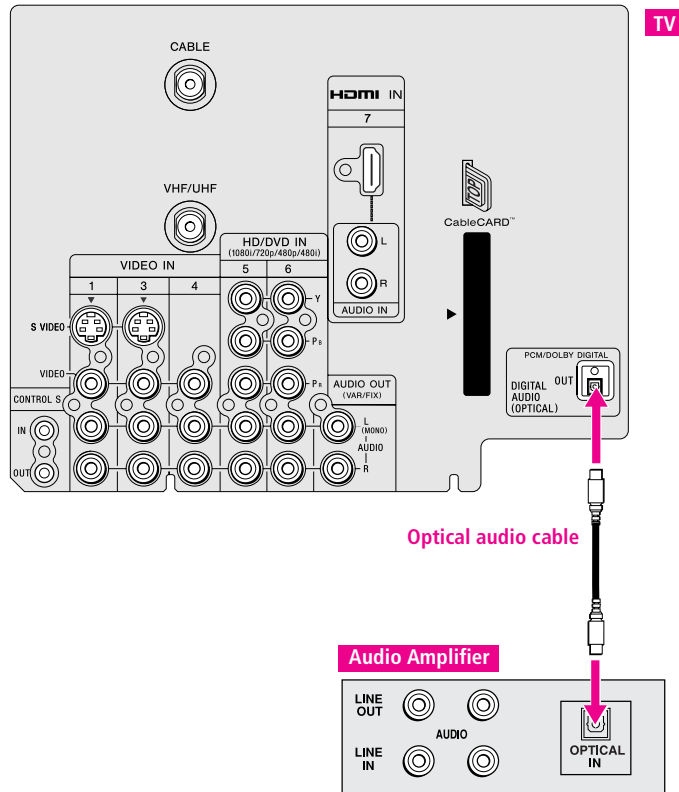

 Because all equipment does not output digital audio, you should also connect the TV's analog audio output jacks to the amplifier's analog audio input jacks, as described on page 36.



## Using the CONTROL S Feature

CONTROL S allows you to control your system and other Sony equipment with one remote control. In addition to allowing you to control multiple devices with one remote control, the CONTROL S feature allows you to always point your remote control at your TV, instead of having to point it at the other equipment, which might be hidden or out of direct line of sight.

Use CONTROL S IN to send signals to the TV.

Use CONTROL S OUT to send signals to connected equipment.

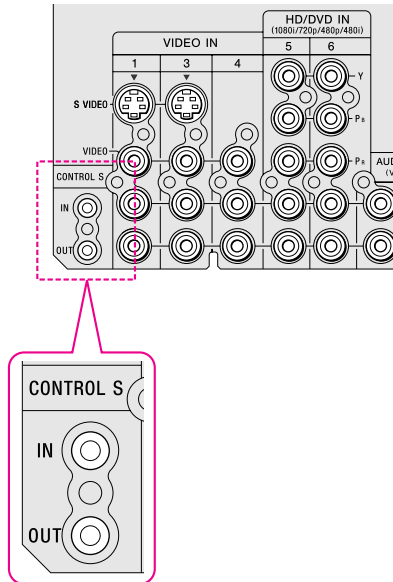

## Using CableCARD

CableCARD provides cable subscribers with access to digitally encrypted cable channels — without the need for a set-top box — that will enable you to receive not only standard definition but also high definition television. The CableCARD, which is provided by your cable TV company, is inserted into the TV's rear panel CableCARD slot. After the service is activated with your cable TV company, the card replaces the need for a separate set-top box.

### About Using CableCARD

If you are planning to use a separate cable box for digital cable TV services, you may be able to receive programming using this TV with the CableCARD instead — except in the following circumstances:

- ❑ Your cable TV company does not provide CableCARD service in your viewing area.
- ❑ You want to access your cable company's interactive or advanced features (such as video-on-demand or, in some cases, pay-per-view). At this time, these services require a bidirectional link, which are only available through the use of a separate set-top box. CableCARD is currently a unidirectional device only, and cannot provide these advanced services.

Check with your cable TV company for CableCARD service details, limitations, pricing, and availability, all of which are determined by your cable TV company — not Sony.

### Activating CableCARD Service

Before you can use CableCARD service, you need to insert the CableCARD (supplied by your cable TV company) and activate the service, as described below:

- 1 Turn off the TV.
- 2 Insert the CableCARD into the TV's CableCARD slot.

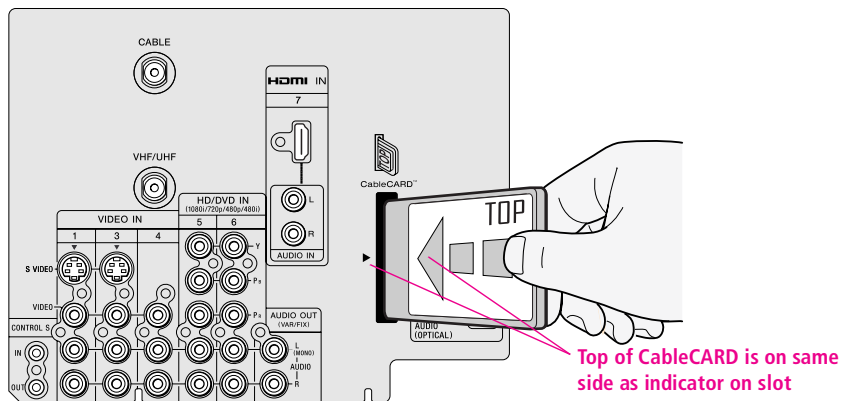

**!** CAUTION: Inserting the CableCARD incorrectly may result in permanent damage to the card and the TV.

 You can also access information about your CableCARD in the Applications Menu (see page 98).

- 3 Gently push the card into the slot until it locks into place.
- 4 Turn on the TV. After 1-2 minutes, the CableCARD setup screen is displayed. This screen includes information your cable TV company will request before they can activate your service.
- 5 Follow the displayed instructions: Phone your cable company. A representative will guide you through the activation process.
- 6 After your CableCARD is activated, your cable TV company will download the service information, including the channel list, to the CableCARD.

After the CableCARD has acquired channels from your cable TV company, the TV tunes to the lowest available channel.

## Removing the CableCARD

In the event you want to cancel your service, contact your cable TV company.

 **Once the CableCARD is removed, your TV will no longer decrypt digital cable TV programming services that require CableCARD.**

- 1 Turn off the TV.
- 2 Push the eject button on the TV's CableCARD slot to release the card.

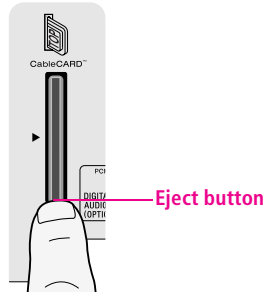

- 3 Pull the CableCARD straight out of the slot to remove it. To set up your normal cable channels, run Auto Program from the TV's Channel Menu (see page 89).

To install a different CableCARD, follow the instructions in "Activating CableCARD Service" on page 41.



## Setting Up the Channel List

After you finish connecting the TV, you need to run the Initial Setup feature, which automatically creates a list of available analog and digital channels. The Initial Setup screens appear when you turn on your TV for the first time after hooking it up.

### Using Initial Setup

 If you are using a CableCARD, Auto Program is disabled for the CABLE input.

#### To run Initial Setup

- 1 Press **POWER** to turn on the TV.  
The Initial Setup screen appears.
  - 2 Using the remote control, move the highlight to the desired language, then press  to select that language.
  - 3 The next screen instructs you to connect your cable/antenna. Check that you've connected your signal source correctly.  
To start Auto Program, highlight **Yes** and then press .
- Auto Program automatically creates a list of receivable analog and digital channels. Auto Program may take 50 minutes or more to complete. A progress bar is displayed while the channel list is being created.

The lowest numbered channel is displayed.

#### To run Auto Program again at a later time

- Use the Auto Program feature as described on page 89.

#### To add individual digital channels

Use the Digital Channel feature as described on page 89.

#### To reset the TV to factory settings

- 1 Press **POWER** to turn on the TV.
- 2 Hold down **RESET** on the remote control.
- 3 Press **POWER** on the TV.
- 4 Release **RESET**. (The TV will turn itself off, then back on.)

## Adjusting the Convergence Automatically (Flash Focus)

The projection tube image appears on the screen in three colors (red, green and blue). If the three colors do not project properly, the color is poor and the picture blurs. Before you use your TV, be sure to run the Flash Focus feature. Flash Focus adjusts the color projection settings automatically.

 Allow the TV to warm up for about 30 minutes before you adjust the convergence with Flash Focus.

 You can also access Flash Focus in the Setup Menu. For details, see page 95.

- 1 Tune to a TV or cable TV program.
- 2 Press the **FLASH FOCUS** button on the front panel of the TV (see page 14).

The cross pattern appears and Flash Focus begins to work.

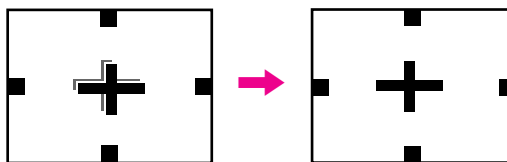

The adjustment is completed when the TV picture returns.

### To Perform Additional Fine Manual Adjustments

Use the manual Convergence feature, described on page 45.

### Notes on Flash Focus



- ❑ You cannot perform any other functions until Flash Focus has completed its cycle. If you perform any other operation while Flash Focus is in progress, the Flash Focus operation is canceled.

## Adjusting the Convergence Manually

The Convergence feature gives you more control over the picture's convergence than the Flash Focus feature, allowing you to fine-tune the convergence.

 Before adjusting the convergence manually for the first time, you must first perform Flash Focus (as described on page 44). Allow the TV to warm up for about 30 minutes before you adjust the convergence.





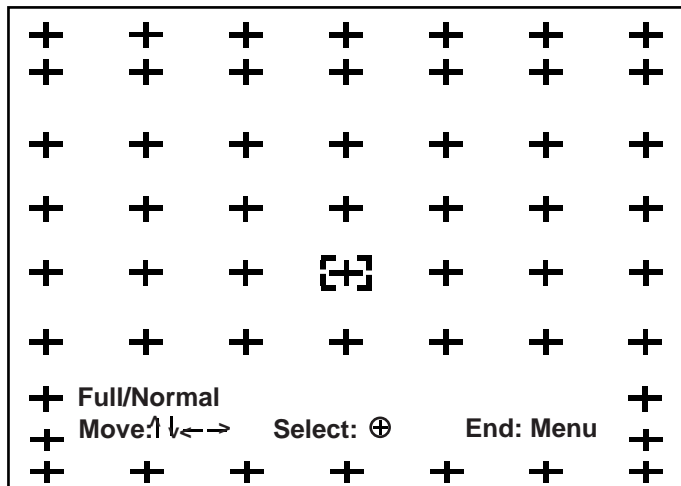

 For details on using the Setup Menu, see page 94.

- 1 Press **MENU** to display the Menu.
- 2 Press **▲** or **▼** to highlight the Setup icon and press .
- 3 Press **▲** or **▼** to highlight **Convergence** and press .

A pattern of white crosses appears, with a yellow  around one of the crosses. Aligned crosses (which do not need adjustment) look white and have little or no red or blue showing. Crosses that are not aligned show red or blue shades beyond their edges.



You can scroll up and down through the 9 x 7 field of crosses to manually converge all portions of the screen.

- 4 Move the  to surround a cross that you want to adjust. Press . The  changes to red.
- 5 If the cross that you selected has red edges, move until the red image is replaced with a white cross. Once you have finished this (or the cross does not have red edges), press . The  changes to blue.
- 6 If the cross you selected has blue edges, move until the blue image is replaced with a white cross. Once you have finished this, press . The  changes to yellow again.
- 7 Repeat steps 4 to 6 to adjust other crosses. When finished, press **MENU** to exit the Setup Menu.

## Notes on Adjusting the Convergence Manually

- ❑ For best results, stand 3 to 5 feet away from the picture when adjusting the convergence. Begin with the crosses in the center area of the screen and, once those are adjusted, move to the crosses on the edges of the screen.
- ❑ You can make separate adjustments in the each of the following viewing modes:
  - ❑ For standard-definition (480i/480p) sources: **Wide Zoom**, **Normal/Full**, and **Zoom** modes (see page 59).
  - ❑ For high-definition (720p/1080i) sources: **Full**, **Wide Zoom**, and **Zoom** modes (see page 60); in Twin View (see page 61).

In each of these viewing modes, the cross pattern looks different, but the adjustment procedure is the same.

- ❑ To optimize the conditions for convergence adjustment, in the Video Menu, set **Mode** to **Pro** or **Movie** and lower the **Picture** level settings (see page 84).
- ❑ You can reset the adjustments by pressing the **RESET** button on the remote control.

# Using the Remote Control

## Overview

This chapter describes how to set up, program, and use the TV's remote control.

Topic	Page
Inserting Batteries	47
Button Descriptions	48
Programming the Remote Control	50
Using Other Equipment with Your TV Remote Control	52

## Inserting Batteries

- 1 Remove the battery cover from the remote control.
- 2 Insert two size AA (R6) batteries (supplied) by matching the **+** and **-** terminals on the batteries to the diagram inside the battery compartment.
- 3 Replace the battery cover.

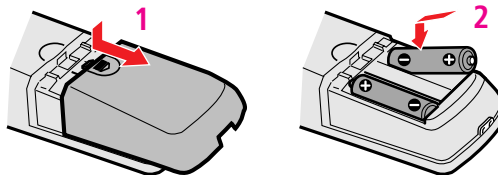

 Remove the batteries to avoid damage from possible battery leakage whenever you anticipate that the remote control will not be used for an extended period.

Handle the remote control with care.







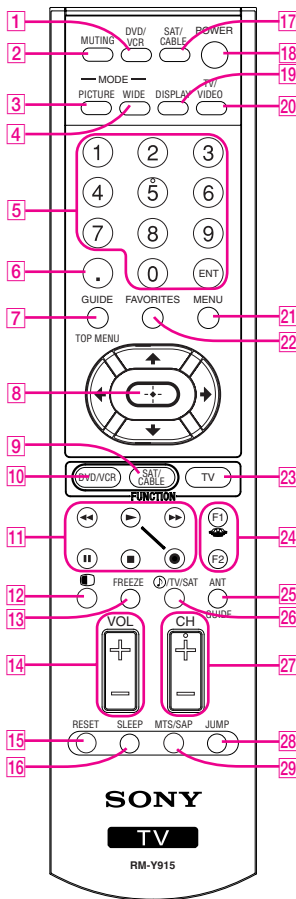

Avoid dropping it, getting it wet, placing it in direct sunlight, near a heater, or where the humidity is high.

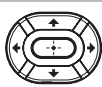





# Button Descriptions

Remote Control



Button	Description
<b>1</b> DVD/VCR POWER	Press to turn on and off the DVD player or VCR.
<b>2</b> MUTE	Press to mute the sound. Press again or press <b>VOL+</b> to restore the sound. *
<b>3</b> PICTURE MODE	Press repeatedly to cycle through the available video picture modes: <b>Vivid</b> , <b>Standard</b> , <b>Movie</b> , <b>Pro</b> . Also available in the Video Menu. For details, see "Selecting Video Options" on page 84.
<b>4</b> WIDE MODE	Press repeatedly to step through the Wide Mode settings. Also available in the Screen Menu. For details, see pages 59 and 88.
<b>5</b> 0 - 9 ENT	Press <b>0 - 9</b> to select a channel; the channel changes after 3 seconds. Press <b>ENT</b> (ENTER) to change channels immediately.
<b>6</b> 	Use with <b>0-9</b> and <b>ENT</b> buttons to select digital channels (for example, 2.1). For details on selecting digital channels, see page 56.
<b>7</b> GUIDE	Press to display the TV's Program Guide (see page 57). When the remote control is set to operate the satellite receiver, press to display the program guide for the satellite receiver.
<b>TOP MENU</b>	Press to display the DVD Menu.
<b>8</b> 	Press <b>↑ ↓ ← →</b> to move the on-screen cursor. To select an item, press <b>⏏</b> .
<b>9</b> SAT/CABLE FUNCTION	Press to have the remote control operate the satellite receiver or cable box.
<b>10</b> DVD/VCR FUNCTION	Press to have the remote control operate the DVD player or VCR.
<b>11</b> Transport Buttons	<ul style="list-style-type: none"> <li> Rewind</li> <li> Play</li> <li> Fast forward</li> <li> Pause</li> <li> Stop</li> <li> Record (press together with )</li> </ul>
<b>12</b> 	Press to turn on and off Twin View. For details, see pages 61-63.
<b>13</b> FREEZE	Press to freeze the window picture. Press again to restore the picture. For details see page 66.
<b>14</b> VOL +/-	Press to adjust the volume. *

\* **MUTE** and **VOL +/-** buttons also function with Sony DVD Dream™ Systems

Button	Description
<b>15</b> RESET	Press to reset the settings to the factory defaults. See pages 85 and 87. Also used to clear Favorite Channels, (see page 64), and Manual Convergence (see page 46).
<b>16</b> SLEEP	Press repeatedly until the TV displays the time in minutes (15, 30, 45, 60, or 90) that you want the TV to remain on before shutting off automatically. To cancel press until <b>Sleep Off</b> appears. While the Sleep feature is set, press once to display the remaining time.
<b>17</b> SAT/CABLE POWER	Press to turn on and off the satellite receiver or cable box.
<b>18</b> TV POWER	Press to turn on and off the TV.
<b>19</b> DISPLAY	Press once to display the current channel number, current time, current Wide Mode, and program information banner (if set). Press again to turn Display off.
<b>20</b> TV/VIDEO	Press repeatedly to cycle through the video equipment connected to the TV's video inputs.
<b>21</b> MENU	Press to display the Menu. Press again to exit from the Menu. For details, see page 83.
<b>22</b> FAVORITES	Press to display the Favorite Channels list. For details, see page 64.
<b>23</b> TV FUNCTION	Press to have the remote control operate the TV.
<b>24</b>  	When the remote control is in <b>DVD/VCR FUNCTION</b> mode, the F1 and F2 buttons control specific DVD and VCR functions. For details, see "Using the F1 and F2 Buttons" on page 53.
<b>24</b>  	When the remote control is in TV mode, press to display the Memory Stick Index. For details, see "Using the Memory Stick Viewer" on page 67.
<b>25</b> ANT	Press to switch between the sources connected to the TV's VHF/UHF and CABLE inputs.
<b>GUIDE</b>	When the remote control is set to operate the satellite receiver, press to display the program guide for the satellite receiver.
<b>26</b> 	Press repeatedly to step through the Audio Effect options. Also available in the Audio Menu. For details, see page 86.
<b>TV/SAT</b>	When the remote control is set to operate the satellite receiver, press to switch between the satellite receiver's TV and SAT (satellite) inputs.
<b>27</b> CH +/-	Press to scan through channels. To scan quickly through channels, press and hold down either <b>CH</b> button.
<b>28</b> JUMP	Press to jump back and forth between two channels. The TV alternates between the current channel and the last channel that was selected.
<b>29</b> MTS/SAP	Press repeatedly to cycle through the Multi-channel TV Sound (MTS) options: <b>Stereo</b> , <b>Auto SAP</b> (Second Audio Program), and <b>Mono</b> . Also available in the Audio Menu. For details, see "Using the Audio Menu" on page 86.

## Programming the Remote Control

The remote control is preset to operate Sony brand video equipment. If you have video equipment other than Sony brand that you want to control with the TV's remote control, use the following procedure to program the remote control.

 **The equipment must have infrared (IR) remote capability in order to be used with the remote control.**

- 1 Turn to the list of "Manufacturer's Codes" on page 51, and find the three-digit code number for the manufacturer of your equipment. (If more than one code number is listed, try the number listed first.)
- 2 While holding down **DVD/VCR FUNCTION** or **SAT/CABLE FUNCTION**, press **RESET**. Then release both buttons. (The **DVD/VCR FUNCTION** and **SAT/CABLE FUNCTION** buttons will flash.)
- 3 Press either **DVD/VCR FUNCTION** or **SAT/CABLE FUNCTION**, depending on which button you want to program.
- 4 Enter the three-digit manufacturer's code number.
- 5 Press **ENT**.

 **You must do step 5 within 10 seconds of step 4, or you must redo steps 3 through 5.**

- 6 To check if the code number works, aim the TV's remote control at the equipment and press the **POWER** button that corresponds with that equipment. If it responds, you are done. If not, try using another code listed for that manufacturer.

### Notes

- ❑ If more than one code number is listed, try entering them one by one until you come to the correct code for your equipment.
- ❑ If you enter a new code number, the code number you previously entered at that setting is erased.
- ❑ In some cases, you may not be able to operate your equipment with the supplied remote control. In such cases, use the equipment's own remote control.
- ❑ Whenever you remove the batteries to replace them, the code numbers may revert to the factory setting and must be reset.

## Manufacturer's Codes

### VCRs

<i>Manufacturer</i>	<i>Code</i>
Sony	301, 302, 303
Admiral (M. Ward)	327
Aiwa	338, 344
Audio Dynamic	314, 337
Broksonic	319, 317
Canon	309, 308
Citizen	332
Craig	302, 332
Curtis Mathes	304, 338, 309
Daewoo	341, 312, 309
DBX	314, 336, 337
Dimensia	304
Emerson	319, 320, 316, 317, 318, 341
Fisher	330, 335
Funai	338
General Electronics	329, 304, 309
Go Video	322, 339, 340
Goldstar	332
Hitachi	306, 304, 305, 338
Instant Replay	309, 308
JC Penney	309, 305, 304, 330, 314, 336, 337
JVC	314, 336, 337, 345, 346, 347
Kenwood	314, 336, 332, 337
LG	332
LXI (SEARS)	332, 305, 330, 335, 338
Magnavox	308, 309, 310
Marantz	314, 336, 337
Marta	332
Memorex	309, 335
Minolta	305, 304
Mitsubishi/MGA	323, 324, 325, 326
Multitech	325, 338, 321
NEC	314, 336, 337
Olympic	309, 308
Optimus	327
Orion	317
Panasonic	308, 309, 306, 307
Pentax	305, 304
Philco	308, 309
Philips	308, 309, 310
Pioneer	308
Quasar	308, 309, 306
RCA/PROSCAN	304, 305, 308, 309, 311, 312, 313, 310, 329
Realistic	309, 330, 328, 335, 324, 338

<i>Manufacturer</i>	<i>Code</i>
Sansui	314
Samsung	322, 313, 321
Sanyo	330, 335
Scott	312, 313, 321, 335, 323, 324, 325, 326
Sharp	327, 328
Shintom	315
Signature 2000 (M.Ward)	338, 327
SV 2000	338
Sylvania	308, 309, 338, 310
Symphonic	338
Tashiro	332
Tatung	314, 336, 337
Teac	314, 336, 338, 337
Technics	309, 308
Toshiba	312, 311
Wards	327, 328, 335, 331, 332
Yamaha	314, 330, 336, 337
Zenith	331

### DVD Changers

<i>Manufacturer</i>	<i>Code</i>
Sony	765
Panasonic	766

### DVD/VCR Combination Units

<i>Manufacturer</i>	<i>Code</i>
Sony	767
Broksonic	776
JVC	775
Panasonic	777
Samsung	774
Toshiba	773
Zenith	768

### HDD/DVD Combination Units

<i>Manufacturer</i>	<i>Code</i>
Sony	770, 771, 772

### DVD 5.1 Ch

<i>Manufacturer</i>	<i>Code</i>
Sony (DAV)	601, 602, 603, 604

### A/V Receivers

<i>Manufacturer</i>	<i>Code</i>
Sony	764

## DVD Players

<i>Manufacturer</i>	<i>Code</i>
Sony	751
General Electric	755
Hitachi	758
JVC	756
Magnavox	757
Mitsubishi	761
Panasonic	753
Philips	757
Pioneer	752
RCA/Proscan	755
Samsung	758
Toshiba	754
Zenith	760

### Cable Boxes

<i>Manufacturer</i>	<i>Code</i>
Sony	230
Hamlin/Regal	222, 223, 224, 225, 226
Jerrold/G.I./ Motorola	201, 202, 203, 204, 205, 206, 207, 208, 218, 222
Oak	227, 228, 229
Panasonic	219, 220, 221
Pioneer	214, 215
Scientific Atlanta	209, 210, 211
Tocom	216, 217
Zenith	212, 213

### Satellite Receivers

<i>Manufacturer</i>	<i>Code</i>
Sony	801
Dish Network	810
Echostar	810
General Electric	802
Hitachi	805
Hughes	804
Mitsubishi	809
Panasonic	803
RCA/PROSCAN	802, 808
Toshiba	806, 807

# Using Other Equipment with Your TV Remote Control

## All Equipment

To Do This ...	Do This ...
Switch the TV's input to the VCR, DVD player, or other connected equipment	Press <b>TV/VIDEO</b> repeatedly to cycle through the video equipment connected to the TV's video inputs.
Set up the TV remote control to operate non-Sony equipment	You must program the remote control the first time you use it. See "Programming the Remote Control" on pages 50 to 51.

## Operating a VCR

To Do This ...	Press
Activate the remote control to operate the VCR	<b>DVD/VCR FUNCTION</b>
Change channels	<b>CH +/-</b>
Record	<b>▶</b> and <b>●</b> simultaneously
Play	<b>▶</b>
Stop	<b>■</b>
Fast forward	<b>▶▶</b>
Rewind the tape	<b>◀◀</b>
Pause	<b>  </b>
Search the picture forward or backward	<b>▶▶</b> or <b>◀◀</b> during playback (release to resume normal playback)

## Operating a Satellite Receiver

To Do This ...	Press
Activate the remote control to operate the satellite receiver	<b>SAT/CABLE FUNCTION</b>
Turn on/off	<b>SAT/CABLE POWER</b>
Select a channel	<b>0-9, ENT</b>
Change channels	<b>CH +/-</b>
Back to previous channel	<b>JUMP</b>
Display channel number	<b>DISPLAY</b>
Display SAT Guide	<b>GUIDE</b>
Display SAT Menu	<b>MENU</b>
Move highlight (cursor)	<b>↑ ↓ ◀ ▶</b>
Select item	<b>◻+◻</b>

## Operating a Cable Box

To Do This ...	Press
Activate the remote control to operate the cable box	SAT/CABLE FUNCTION
Turn on/off	SAT/CABLE POWER
Select a channel	0-9, ENT
Change channels	CH +/-
Back to previous channel	JUMP

## Operating a DVD Player

To Do This ...	Press
Activate the remote control to operate the DVD	DVD/VCR FUNCTION
Play	▶
Stop	■
Pause	
Step through different tracks of the disc	▶▶ to step forward or ◀◀ to step backward
Step through different chapters of a video disc	CH+ to step forward or CH- to step backward
Display the DVD player Menu (Setup)	MENU
Display the DVD Menu	TOP MENU
Move highlight (cursor)	↑ ↓ ◀ ▶

## Using the F1 and F2 Buttons

Using this Sony Device ...	F1 Selects	F2 Selects
DVD/VCR Combination	DVD source	VCR source
DVD HDD Combination	HDD source	DVD source
DVD Dream™ System	Input Select function (toggles through all inputs)	Disc Skip function
DVD Five- and Mega-Disc Changers	Disk Skip function	(no function)



# Using the Features

## Overview

This chapter describes how to use the features of your TV.

<i>Topic</i>	<i>Page</i>
Watching TV	56
Using the Program Guide	57
Using Wide Mode	59
Using Twin View	61
Using Favorite Channels	64
Using the Freeze Function	66



## Watching TV

 For a complete list of all the functions of the remote control, see pages 47-53.

To Do This ...	Do This ...
Activate the remote control to operate the TV	Press <b>TV FUNCTION</b>
Turn on/off the TV	Press <b>TV POWER</b>
Tune directly to a channel	To tune to analog channels, press <b>0-9</b> and then <b>ENT</b> . For digital subchannels, press <b>0-9</b> , <b>⊙</b> , press <b>0-9</b> again, and then <b>ENT</b> . For example, to select subchannel 21.13, press <b>2+1+⊙+1+3</b> , and then press <b>ENT</b> .
	 <b>You can also select channels using the program guide. See pages 57 for details.</b>
Adjust the volume	Press <b>VOL +/-</b>
Mute the sound	Press <b>MUTING</b> (to unmute, press <b>MUTING</b> again or <b>VOL +</b> )
Alternate back and forth between two channels	Press <b>JUMP</b> The TV alternates between the current channel and the last channel tuned.
Display the current channel number, current time, current Wide Mode, and program information banner (if set)	Press <b>DISPLAY</b> . Press <b>DISPLAY</b> again to turn the display off.
Switch the TV's input to the VCR, DVD player, or other connected equipment	Press <b>TV/VIDEO</b> repeatedly to cycle through the video equipment connected to the TV's video inputs.
Change video and audio options, customize the TV's setup, set parental controls, and more	Press <b>MENU</b> to display the Menu. For details, see "Using the Menus" on page 83.
Switch the TV's input between sources connected to the TV's VHF/UHF and CABLE inputs	Press <b>ANT</b> to alternate between sources connected to the TV's VHF/UHF and CABLE inputs.

## Using the Program Guide

The program guide lets you review program information and select both analog and digital channels.

 **The Program Guide cannot be displayed when the TV is tuned to one of the video inputs or if the Channel Fix option is set to anything other than Off (see page 89).**



### To display the program guide:

Press **GUIDE** on the TV's remote control. The program guide appears, with the currently selected program showing in the background.

Program title and description, time remaining, rating information, closed-caption availability, format, resolution (if digital), aspect ratio.

Selectable channel list

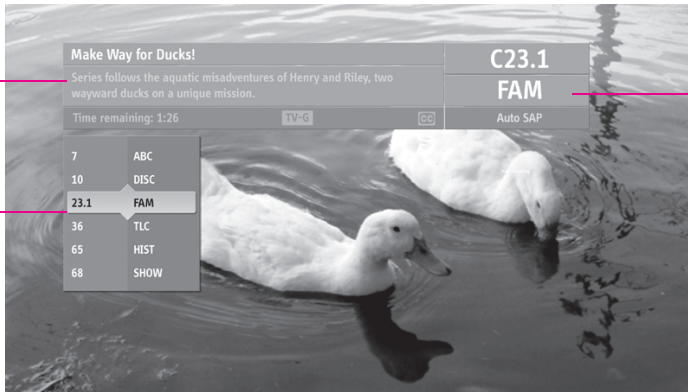

Channel number, call letters, Auto SAP (if available)

 **Program information in the guide is provided by the broadcasters. As a result, it may sometimes include only the channel number, without a program title or description.**

To Do This ...	Do This ...
Scroll through the channel list	Press <b>▲ ▼</b>
Select the currently displayed channel and exit the guide	Press <b>⏏</b> .
Display additional options	Press <b>▶</b> . See "Using Additional Program Guide Options" on page 58.
Exit the Guide (without changing channels)	Press <b>GUIDE</b>

## Using Additional Program Guide Options

Press **➤** while in the program guide's channel list to display the following options, which allow you to customize the settings of the program on the currently tuned channel.

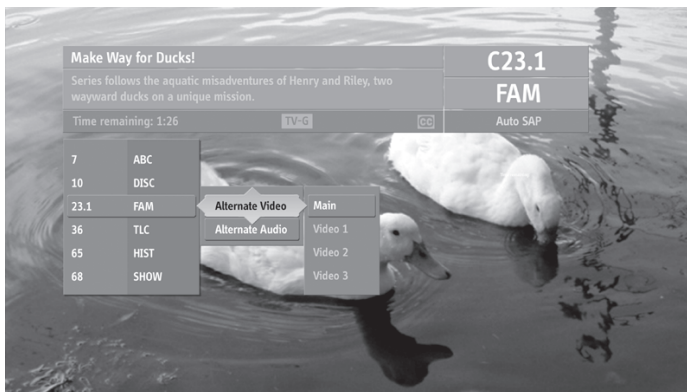

Option	Description
<b>Alternate Video</b> (when available)	Each program has a main video stream (the video that you see when the channel is first tuned), and may have alternate video streams. This option allows you to switch among these alternate video streams.
<b>Alternate Audio</b> (when available)	Each program has a main audio stream (the audio that you hear when the channel is first tuned). This option allows you to switch among these alternate audio streams (e.g., for different languages).









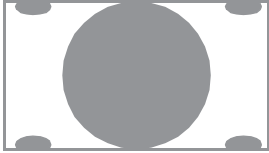

# Using Wide Mode

 You can also access the Wide Mode settings in the Screen Menu. For details, see page 88.

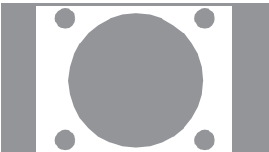
The Wide Mode feature lets you change the picture size for both standard-definition (480i/480p) and high-definition (720p/1080i) sources.

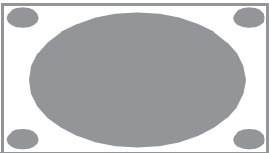
- Press **WIDE MODE** repeatedly to toggle through the following Wide Mode settings.

## Using Wide Mode with Standard Definition (480i/480p) Sources

Example	Description
  <b>Wide Zoom</b>	<b>Wide Zoom</b> enlarges the center portion of the picture proportionately. The left and right edges of the picture are stretched to fill the 16:9 screen. 
  <b>Normal</b>	<b>Normal</b> displays the 4:3 picture in its original size. Bars are shown to fill the 16:9 screen. 
  <b>Full</b>	<b>Full</b> stretches the 4:3 picture horizontally, to fill the 16:9 screen. 
  <b>Zoom</b>	<b>Zoom</b> enlarges the 4:3 picture proportionately to fill the 16:9 screen. Some clipping may occur. <b>Zoom</b> is useful for watching Letterbox movies. 

When you change channels or inputs, the Wide Mode settings revert to the **4:3 Default** setting in the Screen Menu. To retain the current Wide Mode setting as channels and inputs are changed, set **4:3 Default** to **Off**. For details, see page 88.

# Using Wide Mode with High-Definition (720p/1080i) Sources

Example	Description
---------	-------------



Full (native 16:9)

**Full** displays the picture at its original size. If the source is a 16:9 high-definition (720p/1080i) signal, the picture fills the screen.

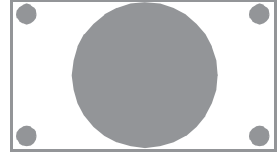

Full (upconverted 4:3)

If the source is a 4:3 standard-definition signal that has been upconverted, bars are shown to fill the 16:9 screen.

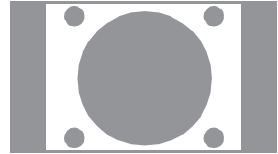

Wide Zoom

**Wide Zoom** enlarges the center portion of the picture proportionately. The left and right edges of the picture are stretched to fill the 16:9 screen.

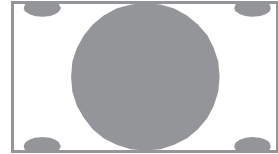

Zoom

**Zoom** enlarges the picture proportionately, both vertically and horizontally. Some clipping may occur.



## Using Twin View

Twin View lets you see two pictures from two sources — from an antenna, VCR, DVD, etc. — on the screen at the same time. You hear the sound from only one of the sources at a time, but you can choose which source's sound is selected. You can also change the relative size of each of the pictures.

### Displaying Twin Pictures

- 1 Tune the TV to a working channel.
- 2 Press .

A second picture appears. The active picture is highlighted.

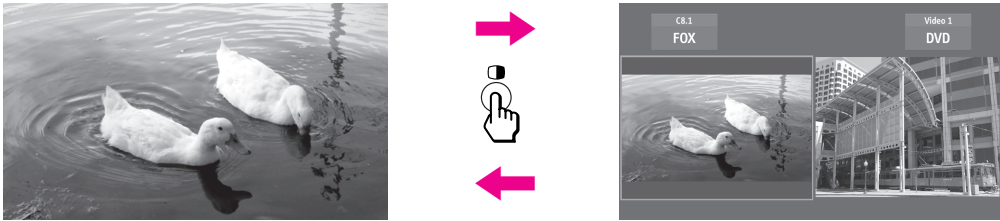

To cancel Twin View and watch the active picture

- Press  or .

### Factors Affecting Twin View

- If you use a cable box to view all channels, the same channel appears in both windows of Twin View because the cable box unscrambles only one channel at a time.
- If you use a cable box, you can view the cable box output in one Twin View window and view a different source (such as a VCR or DVD player) in the second window by using the **TV/VIDEO** button. For details, see “Connecting Optional Equipment” on page 22.
- Digital sources, as well as any sources connected to the VIDEO 5, VIDEO 6, VIDEO 7 inputs, display in the left window, but not in the right window.
- If you are viewing a 4:3 source and a 16:9 enhanced source (such as a DVD) side by side in Twin View, the 4:3 source appears larger.
- Twin View does not display channels that are blocked by parental settings (see page 91).

## Activating the Picture

You can use the **←** and **→** buttons to activate the left and right pictures while using Twin View.

### To Do This ...

To activate the picture in the right window

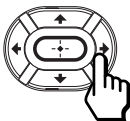

Press **→**.



To activate the picture in the left window

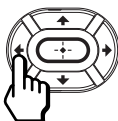

Press **←**.



## Functions Available in the Active (Highlighted) Window

To Do This ...	Do This ...
Tune to a channel	To tune to analog channels, press <b>0-9</b> and then <b>ENT</b> . For digital subchannels, press <b>0-9</b> , <b>⊙</b> , press <b>0-9</b> again, and then <b>ENT</b> . For example, to select subchannel 21.13, press <b>2+1+⊙+1+3</b> , and then press <b>ENT</b> .
Adjust the volume	Press <b>VOL +/-</b>
Mute the sound	Press <b>MUTING</b> (press again to unmute)
Switch the TV's input between sources connected to the TV's VHF/UHF and CABLE inputs	Press <b>ANT</b>
Switch the TV's input between sources connected to the TV's A/V inputs	Press <b>TV/VIDEO</b>
Change the picture size	Press <b>↕</b> or <b>↔</b> . (For details, see "Changing the Picture Size" on page 63.)

## Changing the Picture Size

The zoom feature lets you vary the relative size of the left and right pictures.

To Do This ...

Enlarge the active picture



Press .

Make the active picture smaller

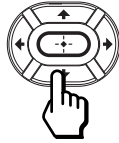

Press .

When you adjust the picture sizes, the TV memorizes the change. The next time you use the Twin View function, the memorized sizes appear.

Do This ...







## Using Favorite Channels



The Favorite Channels feature lets you select programs from a list of up to 16 favorite channels that you specify. You can create a list using the Favorite Channels option in the Channel Menu, or by using the Add to Favorites feature in the Favorite Channels guide.

### Using the Channel Menu



 For details on using the Channel Menu, see page 89.

- 1 Press **MENU** to display the Menu.
- 2 Press **▲** or **▼** to highlight the Channel icon and press .
- 3 Press  to select **Favorite Channels**.
- 4 Use the **0-9** and **ENT** buttons to enter the channel number that you want to assign to the Favorite Channel number. A preview of the highlighted channel appears in the upper right of the screen.

 To enter digital channel numbers in step 4, use the **0-9**, , and **ENT** buttons.

Digital channels do not display in the preview window.

- 5 To add more channels to your favorites list, repeat step 4.  
To clear a Favorite Channel, press **▲** or **▼** to highlight the channel you want to clear and then press **RESET**.
- 6 Press **MENU** to exit the Menu.

## Using the Favorite Channels Guide



- 1 Press **FAVORITES**. The Favorite Channels list appears.

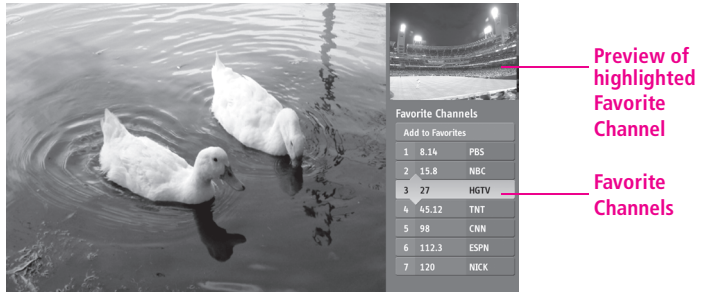

- 2 Press **▲** or **▼** to highlight the channel you want to watch. A preview of the highlighted Favorite Channel appears.

 **Digital channels do not display in the preview window.**

To add the current channel to the list of Favorite Channels, highlight **Add to Favorites** and press **(+)**.

To change your Favorite Channels list, highlight **Edit Favorites** and press **(+)**.

- 3 Press **(+)** to select the channel you want to watch.

## Using the Freeze Function

The **FREEZE** button allows you to temporarily capture a program's picture. You can use this feature to write down information such as phone numbers, recipes, etc.

 **The Freeze feature is not available while using Twin View.**

- 1 When the program information you want to capture is displayed, press **FREEZE**.
- 2 The TV switches to Twin View mode and displays the "frozen" picture on the right, while the current program continues on the left.



**Current  
program  
in progress**



**Frozen  
picture**

- 3 To cancel and return to normal viewing, press **FREEZE** (or just tune to another channel).

# Using the Memory Stick Viewer

## About Memory Stick



Memory Stick (sold separately) is a compact, portable, and versatile Integrated Circuit recording medium with a data capacity that makes it perfect for portable applications, such as digital photography. Memory Stick is specially designed for sharing digital data among Memory Stick compatible products such as digital cameras and digital video cameras. Because it is removable, Memory Stick can also be used for external data storage.

The Memory Stick Viewer on your TV allows you to view files that are stored on Memory Stick media. You can view:

- ❑ Digital photos (JPEG files)
- ❑ Movies (MPEG1 files)

You can also play slide show background music using MP3 files (or m3u playlists) stored on your Memory Stick.

For more information about handling Memory Stick media, see “Notes on Using Memory Stick Media” on page 81.

---

## Features

With the Memory Stick Viewer, you can:

- ❑ View photo (JPEG) and movie (MPEG1) files in a thumbnail index or Slide Show
- ❑ Set customized Slide Show options, including transitions and background audio
- ❑ Pan, zoom, and rotate photos
- ❑ Mark photos and set quantities of prints to be output when the Memory Stick is inserted into your photo printer (not supplied)
- ❑ Lock (protect) or delete files on the Memory Stick

---

## Memory Stick Compatibility

This television is compatible with the following Sony brand Memory Stick media types:

- ❑ Memory Stick Media
- ❑ Memory Stick Duo and PRO Duo Media (without the Memory Stick adaptor)

 **The Memory Stick slot on your TV has been designed to accommodate standard and compact versions of Memory Stick. It is not necessary to use an adaptor for Memory Stick Duo and Memory Stick PRO Duo. If you use an adaptor it may damage the adaptor and Memory Stick slot.**

- ❑ Memory Stick Media with Memory Select Function
- ❑ Memory Stick PRO Media

### About Memory Stick PRO Media

Memory Stick PRO media features vary by and are dependent upon the design of host hardware devices. Memory Stick PRO in this television has been tested to support up to 1 GB media capacity and does not support high-speed transfer, MagicGate copyright protection technology, or access control security features.

---

## Memory Stick Functionality

Sony cannot guarantee or assure the Memory Stick functionality on this television in the following cases:

- ❑ You are using non-Sony brand Memory Stick media.
- ❑ You are using video or audio clips that have been processed on a computer.
- ❑ You are using files that were obtained from the Internet or from a printed film processing center.
- ❑ The Memory Stick has been formatted on a personal computer.

Sony recommends that you back up all data stored on Memory Stick media to avoid potential data loss. In the above two cases, in order to avoid potential data corruption that may occur, be sure to back up data prior to use with the TV's Memory Stick Viewer. Sony cannot accept responsibility in the event that data recorded to Memory Stick media is lost or damaged. For certain non-Sony brand Memory Stick media, you can view images, but you cannot rotate, delete or protect/unprotect images on the television. An error message will occur if you attempt any of these operations. This is a result of the unique file directory structure on these particular flash memory media and is not a malfunction of the television.

---

## **File Compatibility**

The Memory Stick Viewer is compatible with JPEG images taken with Sony digital still cameras and MPEG1\* movies taken with Sony digital cameras and camcorders. In order to be viewable in the Memory Stick Viewer, the files must have the following file name extensions:

<i>File Type</i>	<i>Supported File Name Extensions</i>
JPEG	.jpg .jpeg
MPEG1	.mpg .mpeg

---

## **Trademark Information**

Memory Stick, Memory Stick Duo, Memory Stick PRO, Memory Stick PRO Duo, and MagicGate are trademarks of Sony Corporation.

---

\*Some variations of MPEG1 movies may not play back correctly.

# Inserting and Removing a Memory Stick

## Inserting a Memory Stick

 The Memory Stick slot on your TV has been designed to accommodate standard and compact versions of Memory Stick. It is not necessary to use an adapter for Memory Stick Duo and Memory Stick PRO Duo. If you use an adapter it may damage the adapter and Memory Stick slot.

- 1 Locate the Memory Stick slot (see page 14) and insert the Memory Stick into the Memory Stick slot as illustrated below. When inserted properly, it should slide in with little resistance and click into place.

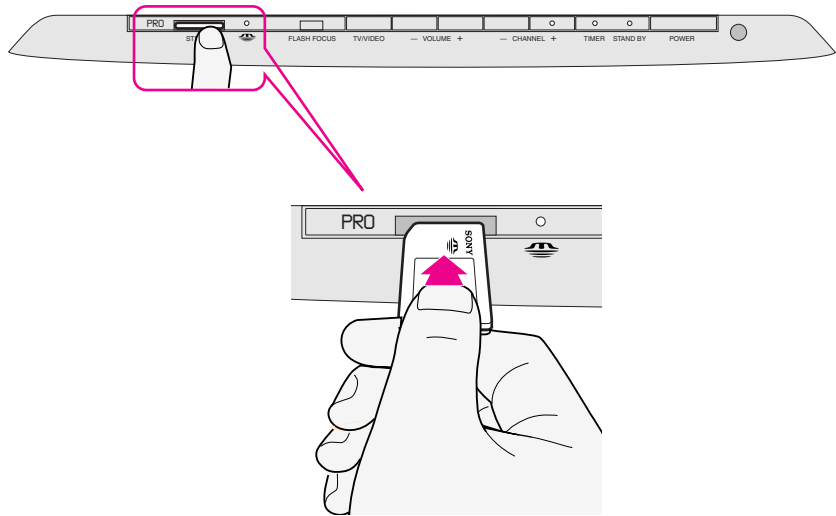

 Be sure to insert the Memory Stick in the correct direction. If the Memory Stick is forced in the wrong way, it may become damaged. Insert only Memory Stick media into the Memory Stick slot. Attempting to insert other objects into the slot may damage the TV.

To remove the Memory Stick, see “Removing a Memory Stick” on page 71.

---

## Removing a Memory Stick

### To remove a Memory Stick

- 1 Check that the Memory Stick indicator is off. (When the light is on, this indicates that the TV is reading data from the Memory Stick.)

 Removing the Memory Stick while a file is being accessed (when the Memory Stick LED on the TV's front panel is lit) may damage the Memory Stick or its contents.

- 2 Push the Memory Stick gently into the slot, and then release it. The Memory Stick media is ejected.

 Do not pull out the Memory Stick without first pushing it in; otherwise, the TV's locking mechanism may become damaged.

- 3 Pull the Memory Stick completely out of the slot.

 To protect small children from injury from Memory Stick Media, remove all Memory Stick media from the TV's Memory Stick slot and store it in a safe location when it is not in use.



## Using the Memory Stick Index





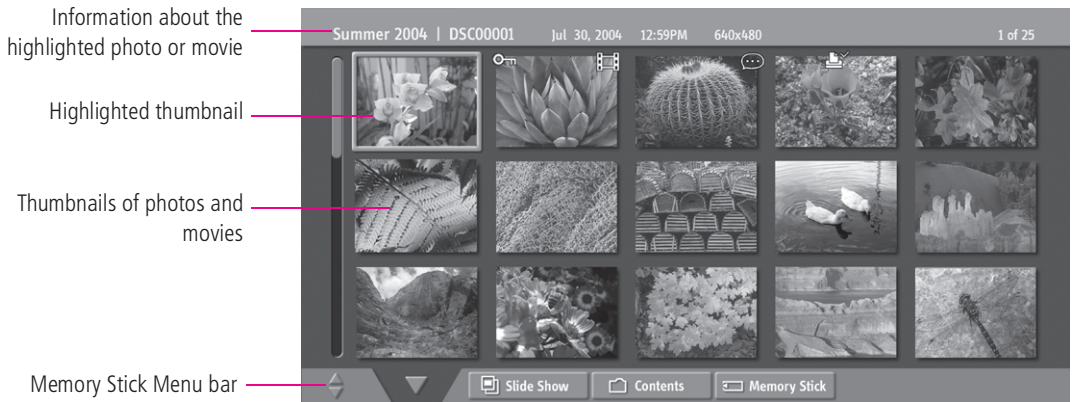

Turn on the TV and insert a Memory Stick that contains the photo or movie files you want to view. For details, see page 70.

 **If the Memory Stick Index does not appear, press the F1 button on the remote control.**

The Memory Stick Index appears, which displays thumbnail images of the files stored on the Memory Stick.



### About the Icons on the Thumbnail Images

-  Indicates the thumbnail is a movie (MPEG1) file instead of a photo (JPEG) file.
-  Indicates the thumbnail is locked. Locked files cannot be changed or deleted. For details, see "Protect" on page 75.
-  Indicates that the photo is marked to be printed.
-  Indicates that the photo has an associated voice memo.

## Using the Memory Stick Index

The following describes how to use the Memory Stick Index.

To Do This ...	Do This ...
Move the highlight to a photo, voice memo (🗣️), or movie (🎬) thumbnail	Press <b>▲ ▼ ◀ ▶</b> .
Display the highlighted photo, voice memo, or movie file full screen	Press <b>⏏</b> . For details, see “Viewing Photos” on page 74 and “Playing Movies” on page 77.
Display the next page of thumbnails	<ol style="list-style-type: none"><li>1 Press <b>▼</b> to select <b>▼</b>.</li><li>2 Press <b>▼</b> to display the next page of thumbnails.</li></ol>
Display the previous or next page of thumbnails	<ol style="list-style-type: none"><li>1 Press <b>▼</b> to select <b>▼</b>.</li><li>2 Press <b>◀</b> to select <b>◀</b>.</li><li>3 To go to the previous page, press <b>▲</b>. To go to the next page, press <b>▼</b>.</li></ol>
Use the Memory Stick Menu bar to access additional options	<ol style="list-style-type: none"><li>1 Press <b>▼</b> to select <b>▼</b>.</li><li>2 Press <b>◀</b> or <b>▶</b> to select <b>Slide Show</b>, <b>Contents</b>, or <b>Memory Stick</b>.</li><li>3 Press <b>▲</b> or <b>▼</b> to select the option you want to change.</li></ol> <p>For details on these options, see “Memory Stick Index Menu Bar Options” on page 79.</p>
Move the highlight from the Memory Stick Menu bar back to the thumbnails	<ol style="list-style-type: none"><li>1 Press <b>◀</b> or <b>▶</b> to select <b>▼</b>.</li><li>2 Press <b>▲</b> to return to the currently displayed thumbnails, or <b>▼</b> to display the next page of thumbnails.</li></ol>
Exit Memory Stick Viewer	Press the <b>F1</b> button on the remote control.

## Viewing Photos

When you select a photo from the Memory Stick Index (described on page 72), it displays as shown below, with the following controls.

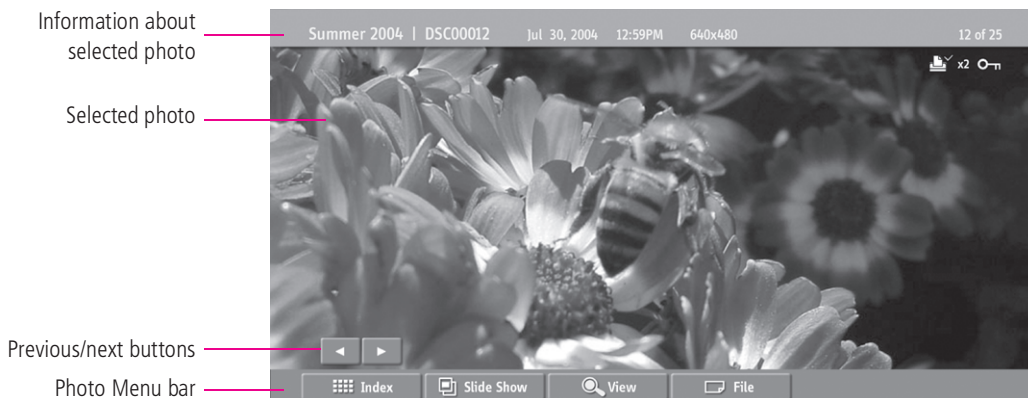

**JPEGs captured using a digital video camera may appear to display motion in full screen. This is a result of the way digital video cameras record still images, and is not a result of a malfunction with the TV.**

### Photo Controls

When the Menu is hidden, press ◀ or ▶ to go to the previous or next photo.

To Do This ...	Do This ...
Display the next or previous file on the Memory Stick	Highlight the ◀ ▶ (Previous/Next) button. Then press ◀ to go to the previous file, or ▶ to go to the next file.
Hide the Photo Menu bar, displaying only the photo	With the highlight in the Photo Menu bar, press ↓.
Display the hidden Photo Menu bar	Press ↑.
Play the JPEG voice memo (🗣️ files only)	Highlight ▶ (Play) and then press (⏮). To pause the voice memo, highlight    (Pause) and then press (⏮).
Display the Memory Stick Index again	Highlight <b>Index</b> in the Photo Menu bar and press (⏮). For details on the Memory Stick Index, see page 73.
Access additional options in the Photo Menu bar	See “Photo Menu Bar Options” on page 75.
Exit Memory Stick Viewer	Press the <b>F1</b> button on the remote control.



## Photo Menu Bar Options

The Photo Menu bar lets you access additional photo viewing options.

### To access the Photo Menu bar

- 1 Press ◀ or ▶ to select **Index**, **Slide Show**, **View**, or **File**.
- 2 Press ▲ or ▼ to select the desired option.

Option	Description
<b>Index</b>	Displays the Memory Stick Index, with the highlight on the thumbnail of the currently displayed photo. For details, see “Using the Memory Stick Index” on page 72.
<b>Slide Show</b>	Displays the Slide Show Menu. For details, see “Slide Show Menu Options” on page 79.
<b>View</b>	<b>Rotate</b> Allows you to rotate the photo in 90 degree increments clockwise or counterclockwise. For details, see “Using Rotate” on page 76.
	<b>Zoom/Pan</b> Allows you to magnify and pan across the photo. For details, see “Using Zoom and Pan” on page 76.
<b>File</b>	<b>Protect</b> Allows you to the protect the JPEG file from any changes. When a JPEG file is protected, it cannot be rotated or deleted. Select <b>On</b> or <b>Off</b> .
	<b>Print Quantity</b> Allows you to indicate the number of prints to make of the specific photo when the Memory Stick is inserted into a compatible photo printer (not supplied).
	<b>Delete</b> Deletes the JPEG file from the Memory Stick. You cannot delete a JPEG file that has been protected (or if the Memory Stick is locked).

 JPEG files that are protected are indicated by the Lock  icon.

 The **Print Quantity** feature is also known as DPOF (Digital Print Order Format).

## Using Zoom and Pan

### To Zoom and Pan a photo

- 1 In the Photo Menu bar, highlight **View**.
- 2 Highlight **Zoom/Pan** and press **(+/-)**.
- 3 Specify the zoom center point by pressing **← → ↑ ↓**; then press **(+/-)** to set the center.

The Zoom and Pan controls are displayed.

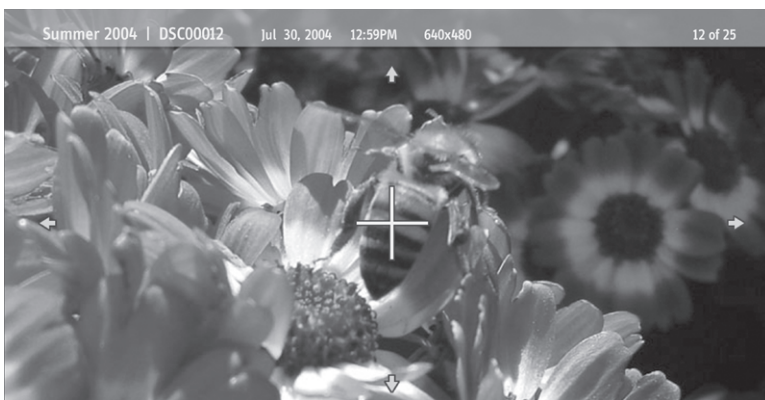

#### To Do This ...

Zoom in (increase magnification) or out (decrease magnification)

Pan (move the photo left, right, up, down)

Exit the Zoom/Pan controls

Exit Memory Stick Viewer

#### Do This ...

Highlight **Zoom** and press **↑** to zoom in or **↓** to zoom out.

For help on using the Zoom function, press **(+/-)**.

(You can use the Pan function only when the photo is magnified using Zoom.)

Highlight **Pan** and press **(+/-)**. Then press **← → ↑ ↓** to pan around the photo.

To stop using Pan, press **(+/-)**.

Highlight **Exit** and press **(+/-)**.

Press the **F1** button on the remote control.

## Using Rotate

### To Rotate a photo

- 1 In the Photo Menu bar, highlight **View**.
- 2 Highlight **Rotate**.
- 3 To rotate clockwise, highlight **Clockwise** and press **(+/-)**.  
To rotate counterclockwise, highlight **Counterclockwise** and press **(+/-)**.

The photo is rotated 90 degrees each time you press **(+/-)**.











## Playing Movies

When you select a movie from the Memory Stick Index (described on page 72), it displays as shown below, with the following controls.





### Movie Controls

 The quality of the movie when enlarged depends on the resolution of the MPEG1 file. See your camera's instruction manual for details.

To Do This ...	Do This ...
Enlarge the movie window	Highlight <b>Enlarge</b> , and then press  . To display the movie controls again, press  . When the movie ends, the movie controls are displayed again.
Play the movie with the movie controls displayed	Highlight  (Play) and then press  .
Pause the movie	Highlight  (Pause) and then press  .
Display the previous or next file on the Memory Stick	Highlight the  (Previous/Next) button. Then press  to go to the previous file, or  to go to the next file.
Hide the Movie Menu bar, displaying only the movie	With the highlight in the Movie Menu bar, press  .
Display the hidden Movie Menu bar	Press  .
Access additional options in the Movie Menu bar	See "Movie Menu Bar Options" on page 78.
Exit Memory Stick Viewer	Press the <b>F1</b> button on the remote control.

## Movie Menu Bar Options

 MPEG1 files that are protected are indicated by the Lock  icon.

### To access the Movie Menu bar

- 1 Highlight **Index** in the Movie Menu bar.
- 2 Press **←** or **→** to select **Index**, **Slide Show**, or **File**.
- 3 Press **↑** or **↓** to select the desired option.

Option	Description
<b>Index</b>	Displays the Memory Stick Index, with the highlight on the thumbnail of the currently displayed movie.
<b>Slide Show</b>	Displays the Slide Show Menu. For details, see “Slide Show Menu Options” on page 79.
<b>File</b>	<b>Protect</b> Allows you to the protect the MPEG1 file from any changes. When an MPEG1 file is protected, it cannot be deleted. Select <b>On</b> or <b>Off</b> .
	<b>Delete</b> Deletes the MPEG1 file from the Memory Stick. You cannot delete an MPEG1 file that has been protected (or if the Memory Stick is locked).

# Memory Stick Index Menu Bar Options

## Slide Show Menu Options

 The Slide Show Menu is the same whether you select it from the Memory Stick Index (page 72), Photo (page 74), or Movie (page 77) Menus.

 When you select **Complete List**, it may take a moment to display the list of all MP3 files.

 Some JPEG files may take longer to display than others, which may make it seem longer than the interval you selected for **Slide Advance**.

 You can also display file information using the **DISPLAY** button on the remote control.

The Slide Show Menu includes the following options:

Option	Description
<b>Start</b>	Starts the Slide Show.
<b>Music</b>	Allows you to select background audio to play during the Slide Show.
<b>Off</b>	No additional background audio is played during the Slide Show. Audio that is associated with the JPEG or MPEG1 files will play.
<b>Play Memory Stick</b>	Plays all MP3 files on the Memory Stick. The <b>Piano</b> MP3 file and any MP3 file playlists are not played.
<b>Piano (built-in)</b>	Plays the MP3 file stored in the TV's internal memory.
<b>(List of MP3 Files and Playlists)</b>	Displays a list of all MP3 files and MP3 file playlists found at the top level (root) of the Memory Stick. To show additional MP3 files stored in other folders on the Memory Stick, select <b>Complete List</b> .
<b>Complete List</b>	Displays a list of all available MP3 files.
<b>Transition Effect</b>	Allows you to select an effect to be used when advancing to the next file in the Slide Show.
<b>Slide Advance</b>	Allows you to specify when to advance to the next slide.
<b>Fast</b>	Slide advances after about 3 seconds.
<b>Medium</b>	Slide advances after about 6 seconds.
<b>Slow</b>	Slide advances after about 12 seconds.
<b>Manual</b>	Slide advances only after you press <b>◀</b> or <b>▶</b> .
<b>File Information</b>	Determines whether file information is shown when the file is displayed full screen. Select <b>On</b> or <b>Off</b> .
<b>Repeat</b>	<b>On</b> Slide Show continuously loops. <b>Off</b> Slide Show plays once through all files and ends.



## Contents Menu Options

 The Rotate function does not change the file's modification date.

The Contents Menu includes the following options:

Option	Description
<b>Select Folder</b>	Allows you to select different folders to view in the Memory Stick Viewer.
<b>Digital Camera Folders</b>	Selects all folders within the directories defined by the DCF rules used by Sony digital cameras (see page 81). JPEG and MPEG1 files in those directories are recognized even if they do not conform to the DCF file naming rules.
<b>Select a Folder</b>	Allows you to access individual folders on the Memory Stick.
<b>File Order</b>	Allows you to change the order in which the Memory Stick files are displayed.
<b>Date Order</b>	Displays files in chronological order by modification date.
<b>Date Order Reverse</b>	Displays files in reverse chronological order by modification date.
<b>Alphabetical</b>	Displays files in alphabetical order by filename.
<b>Filter</b>	Allows you to selectively display specific file types within the selected folder.
<b>Show Photos and Movies</b>	Displays all readable files.
<b>Show Photos Only</b>	Displays only photo (JPEG) files.
<b>Show Movies Only</b>	Displays only movie (MPEG1) files.
<b>Show All Print Marks</b>	Displays all files that are marked for printing. For details, see "Print Quantity" on page 75.

## Memory Stick Menu

The Memory Stick Menu displays the current status of the Memory Stick, including total capacity, used capacity, and free capacity.

## Notes on Using Memory Stick Media

---

### **About DCF File Names**

Most Sony brand digital still and video cameras automatically record still photo and movie files using DCF compliant directory and file names.

If you selected the **Digital Camera Folders** option, as described on page 80, you might want to have your digital camera's instruction manual handy in order to check how files and directories are organized for your specific model of digital camera.

DCF stands for "Design Rules for Camera File Systems," which are specifications established by the Japan Electronic Industry Development Association (JEIDA).

## Memory Stick Precautions

When using Memory Stick media, follow these precautions:

- ❑ To avoid permanent damage to still image data, do not turn off the TV or remove Memory Stick media from the insertion slot while data is being read (as indicated by the Memory Stick indicator light being on).
- ❑ Avoid touching the terminal of Memory Stick media or bringing it into contact with a metal object.
- ❑ Do not drop, bend, or submit Memory Stick media to external shock.
- ❑ Do not disassemble or modify Memory Stick media.
- ❑ Avoid getting liquid on Memory Stick media.
- ❑ Apply labels only within the designated label area.

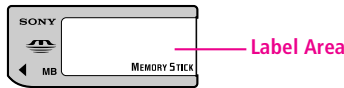







- ❑ To avoid permanent damage to still image data, do not use or store Memory Stick media in a location subject to:
  - ❑ High temperature (such as near a heater or inside a hot car)
  - ❑ High humidity
  - ❑ Direct sunlight
  - ❑ Corrosive substances
  - ❑ Magnetic fields
  - ❑ Excessive dust
  - ❑ Static electricity or electric noise
  - ❑ Electric surges
- ❑ Store and carry Memory Stick media in its original case to ensure protection of stored data.
- ❑ Save a backup of stored data.

# Using the Menus

## Overview

The Menu gives you access to the following features:

<i>Menu</i>	<i>Description</i>	<i>Page</i>
	The Video Menu allows you to make adjustments to your picture settings. It also allows you to customize the Picture Mode based on the type of program you are viewing, select Advanced Video options, and more.	84
	The Audio Menu Offers enhanced audio options such as listening to second audio programming (SAP) or customizing the Effect of the sound on your TV.	86
	The Screen Menu allows you to make Wide Mode adjustments and make changes to the screen's vertical center and size.	88
	The Channel Menu allows you to set up a Favorite Channel list, run the Auto Program function, label channels, and more.	89
	The Parental Lock Menu lets you control the viewing of programs based on their ratings.	91
	The Setup Menu provides options for setting up your system, including selecting closed caption modes, labeling video inputs, selecting the language and color of the on-screen Menus, and more.	94
	The Applications Menu lets you display the Memory Stick Viewer, set on/off Timers, access CableCARD and diagnostics information, and more.	97

 Press **MENU** to enter and exit Menus.

## Navigating Through Menus

<i>To Do This ...</i>	<i>Press</i>
Display the Menu	<b>MENU</b>
Move through the Menus	↑ ↓ ← →
Select an option to change	⊖ ⊕
Select (confirm) changed setting	⊖ ⊕ or ←
Exit the Menu	<b>MENU</b>

# Using the Video Menu



To access the Video Menu, follow these steps:

1. Display Menu
2. Highlight 
3. Press to select



To change settings, press **↑ ↓ ← →**.  
Press **↵** to confirm the selection.

To exit the Menu, press **MENU**.



## Selecting Video Options



You can also change the Mode setting using the **PICTURE MODE** button on the remote control.



You can alter the Video Menu settings (**Picture**, **Brightness**, **Color**, etc.) for each Mode.

The Video Menu includes the following options:

Option	Description
<b>Mode</b> <i>Customized picture viewing</i>	<p><b>Vivid</b> Select for enhanced picture contrast and sharpness.</p> <p><b>Standard</b> Select for standard picture settings.</p> <p><b>Movie</b> Select to display a softer picture.</p> <p><b>Pro</b> Select to display a picture with minimum enhancements.</p> <p>To control how the <b>Mode</b> settings (<b>Vivid</b>, <b>Standard</b>, <b>Movie</b>, <b>Pro</b>) are applied to each video input, see <b>Mode Memory</b> on page 85.</p>
<b>Picture</b>	Adjust to increase picture contrast and deepen the color, or decrease picture contrast and soften the color.*
<b>Brightness</b>	Adjust to brighten or darken the picture.*
<b>Color</b>	Adjust to increase or decrease color intensity.
<b>Hue</b>	Adjust to increase or decrease the green tones.
<b>Sharpness</b>	Adjust to sharpen or soften the picture.
<b>Color Temp.</b> <i>White intensity adjustment</i>	<p><b>Cool</b> Select to give the white colors a blue tint.</p> <p><b>Neutral</b> Select to give the white colors a neutral tint.</p> <p><b>Warm</b> Select to give the white colors a red tint (NTSC-Standard).</p>

\* Image retention is accelerated by higher **Picture** and **Brightness** settings. See page 1 for information on image retention.

Option	Description
<b>ClearEdge VM Velocity Modulation</b>	Sharpens picture definition to give every object a sharp, clean edge. Select from <b>High</b> , <b>Medium</b> , <b>Low</b> , <b>Off</b> .
<b>Advanced Video</b>	Select <b>Program</b> to choose among the <b>Advanced Video</b> options.
<b>DRC Mode</b>	Creates a high-resolution picture with 4x density, for high quality sources (i.e., DVD player, satellite receiver).
<b>Interlaced</b>	Recommended for moving pictures.
<b>Progressive</b>	Recommended for still images and text.
<b>CineMotion</b>	Provides an optimized display by automatically detecting film content and applying a reverse 3/2 pulldown process. Moving pictures will appear clearer and more natural-looking.
<b>Color Axis</b>	Allows you to control the emphasis of red tones.
<b>Default</b>	Emphasizes red tones.
<b>Monitor</b>	De-emphasizes red tones.
<b>Noise Reduction</b>	<b>On</b> Reduces repetitive random noise.
	<b>Off</b> Turns off Noise Reduction.
<b>Mode Memory</b>	Allows you to control how the <b>Mode</b> settings ( <b>Vivid</b> , <b>Standard</b> , <b>Movie</b> , <b>Pro</b> ) are applied to TV viewing, Memory Stick viewing, and each video input. For details about Mode settings, see page 84.
<b>On</b>	Set to <b>On</b> to customize <b>Mode</b> settings for each video input. Changing inputs might change the <b>Mode</b> setting.
<b>Off</b>	Set to <b>Off</b> to apply the same <b>Mode</b> settings to all video inputs. Changing inputs does not change the <b>Mode</b> setting.

 For best results, use CineMotion with Video 5 or 6 (HD/DVD IN) or Video 7 (HDMI IN).

**To restore the factory default settings for Video settings:**

- ❑ Press **RESET** on the remote control when in the Video Menu.

## Using the Audio Menu



To access the Audio Menu, follow these steps:

1. Display Menu



2. Highlight

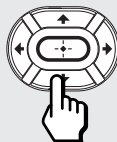

3. Press to select



To change settings, press **↑ ↓ ← →**.  
Press **↵** to confirm the selection.

To exit the Menu, press **MENU**.



### Selecting Audio Options

You can also change the Effect using the **⏸** button on the remote control.

The Audio Menu includes the following options:

Option	Description
<b>Treble</b>	Adjust to decrease or increase higher-pitched sounds.
<b>Bass</b>	Adjust to decrease or increase lower-pitched sounds.
<b>Balance</b>	Adjust to emphasize left or right speaker balance.
<b>Steady Sound</b>	<b>On</b> Select to stabilize the volume.
	<b>Off</b> Select to turn off Steady Sound.
<b>ⓘ The Steady Sound option is not available (it is grayed out) if the Effect option is set to TruSurround or Simulated. To use Steady Sound, set Effect to Off.</b>	
<b>Effect</b>	<b>TruSurround</b> Select for surround sound (for stereo programs only).
	<b>Simulated</b> Adds a surround-like effect to mono programs.
	<b>Off</b> Normal stereo or mono reception.
<b>MTS</b> <i>Enjoy stereo, bilingual and mono programs</i>	<b>Stereo</b> Select for stereo reception when viewing a program broadcast in stereo.
	<b>Auto SAP</b> Select to automatically switch the TV to second audio programs when a signal is received. (If no SAP signal is present, the TV remains in Stereo mode.)
	<b>Mono</b> Select for mono reception. (Use to reduce noise during weak stereo broadcasts.)
<b>ⓘ MTS is available only with analog programs.</b>	

<i>Option</i>	<i>Description</i>
<b>Audio Out</b> <i>Easy control of volume adjustments</i>	This option can be set only when the <b>Speaker</b> option is set to <b>Off</b> .
	<b>Variable</b> The TV's speakers are turned off, but the volume output from your audio system can still be controlled by the TV's remote control.
	<b>Fixed</b> The TV's speakers are turned off and the volume output of the TV is fixed. Use your audio receiver's remote control to adjust the volume through your audio system.
<b>Speaker</b>	<b>On</b> Select to turn on the TV speakers.
	<b>Off</b> Select to turn off the TV speakers and listen to the TV's sound only through your external audio system speakers.

**To restore the factory default settings for Treble, Bass, and Balance**

- ❑ Press **RESET** on the remote control when in the Audio Menu.



# Using the Screen Menu



To access the Screen Menu, follow these steps:

1. Display Menu



2. Highlight



3. Press to select



To change settings, press **↑ ↓ ← →**.  
Press **⏏** to confirm the selection.

To exit the Menu, press **MENU**.

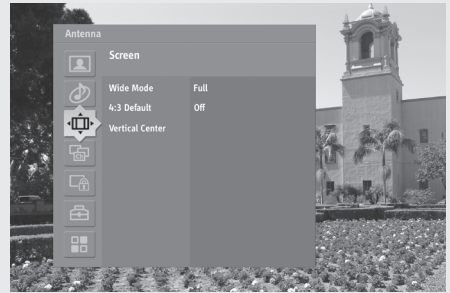

## Selecting Screen Options



You can also change the Wide Mode using the **WIDE MODE** button on the remote control.

The Screen Menu includes the following options:

Option	Description
<b>Wide Mode</b>	Enables you to change the picture size for both standard-definition (480i/480p) and high-definition (720p/1080i) sources. <hr/> For 480i/480p sources Select from: <b>Wide Zoom</b> , <b>Normal</b> , <b>Full</b> , <b>Zoom</b> . For details, see page 59. <hr/> For 720p/1080i sources Select from: <b>Full</b> , <b>Wide Zoom</b> , <b>Zoom</b> . For details, see page 60. <hr/> <b>In some cases, wide-screen programs will be shown in aspect ratios that require the display of bars at the top and bottom of your 16:9 screen. For more details, see page 105.</b>
<b>4:3 Default</b>	Select the default Wide Mode to use for 4:3 sources.  To select a Wide Mode to use when channels or inputs are changed, select from: <b>Wide Zoom</b> , <b>Normal</b> , <b>Full</b> , <b>Zoom</b> . For details, see page 59.  To continue using the current Wide Mode setting when the channel or input is changed, select <b>Off</b> .
<b>Vertical Center</b>	Allows you to move the position of the picture up and down in the window. (Available only in Wide Zoom and Zoom modes.)  Press <b>↑</b> or <b>↓</b> and press <b>⏏</b> to choose a correction between +15 and -15 (Zoom mode), and +10 and -10 (Wide Zoom mode).

# Using the Channel Menu



To access the Channel Menu, follow these steps:

1. Display Menu



2. Highlight

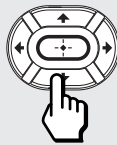

3. Press to select



To change settings, press **↑ ↓ ← →**.  
Press **⏏** to confirm the selection.

To exit the Menu, press **MENU**.

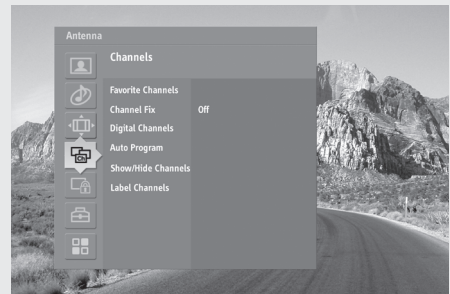

## Selecting Channel Options

The Channel Menu includes the following options:

Option	Description
<b>Favorite Channels</b>	Lets you set up a list of your favorite channels. For details, see "Using Favorite Channels" on page 64.
<b>Channel Fix</b>	<p><b>Off</b> Turns off Channel Fix.</p> <p><b>2-6</b> "Fix" your TV's channel setting to 2–6 (VHF/UHF input) and use the cable box or satellite receiver to change channels.</p> <p><b>C2-C6</b> "Fix" your TV's channel setting to C2–C6 (CABLE input) and use the cable box or satellite receiver to change channels.</p> <p><b>Video 1</b> Use this setting if you have connected the equipment to the A/V input jacks.</p>
<b>Digital Channels</b>	<b>Add</b> Select to add digital channels.
<b>Auto Program</b>	Automatically sets up the channel list on the TV for all receivable channels.

**✍️ Auto Program may take 50 minutes or more to complete. A progress bar will display the approximate progress of the Auto Program and Digital Channels/Add sequences.**

**🔦** If you are using a CableCARD, Auto Program is disabled for the CABLE input. However, you can run Auto Program for the VHF/UHF input.

 Channels that you set to **Hidden** can be accessed only with the **0-9** buttons.

<i>Option</i>	<i>Description</i>
<b>Show/Hide Channels</b>	<p>Allows you to show or hide channels that appear in the Program Guide (page 57) and when you use the <b>CH+/-</b> buttons to channel surf. Channels that are set to <b>Hidden</b> do not appear in the Program Guide or when you use the <b>CH+/-</b> buttons.</p> <ol style="list-style-type: none"><li>1 Press <b>▲</b> or <b>▼</b> to highlight the channel that you want to show or hide. To move between the Major and Digital subchannel lists, press <b>◀</b> or <b>▶</b>.</li><li>2 To change a channel's setting to <b>Shown</b> or <b>Hidden</b>, press <b>⏺</b>.</li><li>3 To show or hide more channels, repeat steps 1 and 2.</li></ol>
<b>Label Channels</b>	<p>Allows you to assign labels (such as station call letters) to channel numbers.</p> <ol style="list-style-type: none"><li>1 Press <b>▲ ▼</b> to scroll through the channel numbers. Then press <b>⏺</b> to select the channel number that you want to assign a label.</li><li>2 Press <b>▲ ▼</b> to scroll through the label characters (A-Z, 0-9, etc.). Then press <b>⏺</b> to select the highlighted character. Repeat to add characters to the label.</li><li>3 To assign labels to more channels, repeat steps 1-2.</li><li>4 Press <b>◀</b> to return to the Channel Menu, or press <b>MENU</b> to exit the Menus.</li></ol>

## Using the Parent Menu



The Parent Menu allows you to set up the TV to block programs according to their content and rating levels.

To access the Parent Menu, follow these steps:

1. Display Menu
2. Highlight 
3. Press to select

MENU

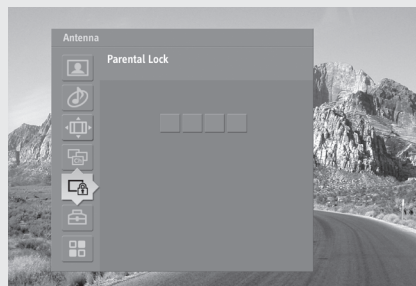
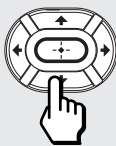

Use the **0-9** buttons on the remote control to enter a four-digit password.

If this is the first time you are creating this password, confirm the password by entering it again. (The Parent Menu options appear.)

To change settings, press **▲ ▼ ◀ ▶**. Press **⏏** to confirm the selection.

To exit the Menu, press **MENU**.

 **You need your password for any future access into the Parent Menu. If you lose your password, see "Lost password" on page 105.**

### Selecting Parent Menu Options

 If you are not familiar with the Parental Guideline rating system, you should select **Child**, **Youth**, or **Y. Adult** to help simplify the rating selection. To set more specific ratings, select **Custom**.

 For descriptions of **Child**, **Youth**, and **Y. Adult** ratings, see page 92.

The Parent Menu includes the following options:

Option	Description
<b>Parental Lock</b>	<b>Off</b> Parental lock is off. No programs are blocked from viewing.
<i>Turn ratings on/off and select a rating system</i>	<b>Child</b> Maximum ratings permitted are: <input type="checkbox"/> US: TV-Y, TV-G, G <input type="checkbox"/> Canada: C, G, TV-Y
<b>Youth</b>	Maximum ratings permitted are: <input type="checkbox"/> US: TV-PG, PG <input type="checkbox"/> Canada: C8+, PG, 8 ans+, TV-PG
<b>Y. Adult (Young Adult)</b>	Maximum ratings permitted are: <input type="checkbox"/> US: TV-14, PG-13 <input type="checkbox"/> Canada: 14+, 13 ans+, TV-14
<b>Custom</b>	Select to set ratings manually. <input type="checkbox"/> US: See page 92 for details. <input type="checkbox"/> Canada: See page 93 for details.
<b>Change Password</b>	For changing your password.
<b>Select Country</b>	<b>U.S.A.</b> Select to use USA ratings (see page 92). <b>Canada</b> Select to use Canadian ratings (see page 93).

## US Models: Selecting Custom Rating Options

 The Content-Based Ratings are linked to the level of the Age-Based Rating. For example, a program with an Age-Based Rating of TV-PG V (Violence) rating may contain moderate violence, while a TV-14 V (Violence) rating may contain more intense violence.

 To ensure maximum blocking capability, set the Age-Based Ratings.

 If you block unrated TV programs, be aware that the following types of programs may be blocked: emergency broadcasts, political programs, sports, news, public service announcements, religious programs and weather.

For US models, the Custom Rating Menu includes the following options. (For Canadian models, see page 93.)

Option	Description
<b>Movie Rating</b>	<b>G</b> All children and General Audience.
	<b>PG</b> Parental Guidance suggested.
	<b>PG-13</b> Parental Guidance for children under 13.
	<b>R</b> Restricted viewing, parental guidance is suggested for children under 17.
	<b>NC-17 and X</b> No one 17 or under allowed.
<b>TV Rating</b> <i>Block programs by their rating, content or both</i>	<b>Age-Based Ratings</b>
	<b>TV-Y</b> All children.
	<b>TV-Y7</b> Directed to children age 7 and older.
	<b>TV-G</b> General Audience.
	<b>TV-PG</b> Parental Guidance suggested.
	<b>TV-14</b> Parents Strongly cautioned.
	<b>TV-MA</b> Mature Audience only.
	<b>Content-Based Ratings</b>
	<b>FV</b> Fantasy Violence.
	<b>D</b> Suggestive Dialogue.
<b>L</b> Strong Language.	
<b>S</b> Sexual situations.	
<b>V</b> Violence.	
<b>Unrated</b> <i>Block programs or movies that are broadcast without a rating</i>	<b>Allow</b> Allows programs and movies that are broadcast without a rating.
	<b>Block</b> Blocks all programs and movies that are broadcast without a rating.

## Viewing Blocked Programs

You can view blocked programs by entering the password. Press the **ENT** button when tuned to a blocked program, then enter the password. This temporarily switches off the Parental Lock. To reactivate the Parental Lock settings, turn off the TV. When the TV is turned on again, your Parental Lock settings are reactivated.

---

## Canadian Models: Selecting Custom Rating Options

For Canadian models, the Custom Rating Menu includes the following options. (For US models, see page 92.)

Option	Description	
English Rating	C	All children.
	C8+	Children 8 years and older.
	G	General programming.
	PG	Parental Guidance.
	14+	Viewers 14 and older.
	18+	Adult programming.
French Rating	G	General programming.
	8 ans+	Not recommended for young children.
	13 ans+	Not recommended for ages under 13.
	16 ans+	Not recommended for ages under 16.
	18 ans+	Programming restricted to adults.
U.S.A. Rating	See "US Models" on page 92 for details.	

---

## Viewing Blocked Programs

You can view blocked programs by entering the password. Press the **ENT** button when tuned to a blocked program, then enter the password. This temporarily switches off the Parental Lock. To reactivate the Parental Lock settings, turn off the TV. When the TV is turned on again, your Parental Lock settings are reactivated.

## Using the Setup Menu



To access the Setup Menu, follow these steps:

1. Display Menu



2. Highlight

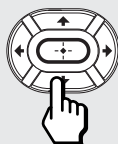

3. Press to select



To change settings, press **↑ ↓ ← →**.  
Press **↵** to confirm the selection.

To exit the Menu, press **MENU**.

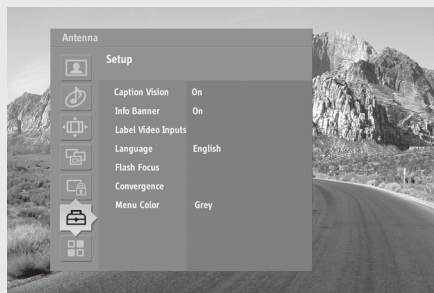



### Selecting Setup Options

The Setup Menu includes the following options:

Option	Description
<b>Caption Vision</b>	Allows you to select from several closed caption modes (for programs that are broadcast with closed caption).
<b>On</b>	Caption Vision is turned on.
<b>Off</b>	Caption Vision is turned off.
<b>Program</b>	Allows you to set basic and advanced Caption Vision options. See “Programming Caption Vision” on page 96.
<b>Info Banner</b>	Set to <b>On</b> or <b>Off</b> . When <b>On</b> , displays the program name, time remaining and other information (if the broadcaster offers this service). Displays when the channel is changed or the <b>DISPLAY</b> button is pressed.

 The **Skip** label is useful for inputs that do not have equipment connected to them.

 You can also access Flash Focus by pressing the **FLASH FOCUS** button on the front panel of the TV.

Option	Description
<b>Label Video Inputs</b>	<p>Allows you to identify A/V equipment you connected to the TV, such as a VCR, DVD, etc. For example, if you have a DVD player connected to the VIDEO 5 jack, you can select the label <b>DVD</b> for the VIDEO 5 input. Then when you press the <b>TV/VIDEO</b> button to change inputs, the Video Label you assigned to that input appears on screen.</p> <ol style="list-style-type: none"> <li data-bbox="662 317 1231 404">1 Press <b>▲</b> or <b>▼</b> to highlight the video input (VIDEO 1-7) to which you want to assign a label. Then press <b>⏏</b> to select the input.</li> <li data-bbox="662 413 1231 473">2 Press <b>▲</b> or <b>▼</b> to highlight one of the displayed labels. Then press <b>⏏</b> to select the label.</li> </ol> <p>You can select from the following labels for each input:</p> <p><b>Video 1-7</b>      <b>VHS, DVD, Receiver, Satellite, Cable Box, 8mm, DTV, Game, LD, Web, Beta, HD, PVR, Skip</b></p> <p> <b>If you select Skip, your TV skips this input when you press the TV/VIDEO button.</b></p>
<b>Language</b>	Select to display all on-screen Menus in your language of choice.
<b>Flash Focus</b>	Allows you to adjust the convergence automatically. For details, see page 44.
<b>Convergence</b>	Allows you to fine-tune the convergence manually. For details, see page 45.
<b>Menu Color</b>	Enables you to select a specific color for the on-screen menus.



## Programming Caption Vision

If you selected the **Program** option under **Caption Vision** (see page 94), you can change the following settings:

<b>Basic</b>	Allows you to select basic analog (EIA-608) closed caption options.
<b>CC1, CC2, CC3, CC4</b>	Displays a printed version of the dialog or sound effects of a program. (Should be set to <b>CC1</b> for most programs.)
<b>Text1, Text2, Text3, Text4</b>	Displays network/station information presented using either half or the whole screen (if available). For closed captioning, set to <b>CC1</b> .
<b>Advanced</b>	Allows you to select advanced digital (EIA-708) closed caption options. Select from the available options.
<b>Digital CC</b>	Allows you to set digital closed captioning to <b>Basic</b> (digital EIA-608) or <b>Advanced</b> (digital EIA-708).
<b>Advanced Settings</b>	Allows you to make additional settings for digital (EIA-708) closed caption options.
	<b>As Broadcast</b>
	<b>Small Text</b>
	<b>Large Text</b>
	<b>Custom ...</b>
	Allows you to customize the following settings:
	<b>Character Size</b> <b>Small, Standard, Large</b>
	<b>Character Style</b> <b>Style 1-7</b>
	<b>Character Color</b> <b>Color 1-8</b>
	<b>Edge Color</b> <b>Color 1-8</b>
	<b>Edge Type</b> <b>None, Raised, Depressed, Outline, Left shadow, Right shadow</b>
	<b>Background Color</b> <b>None, Color 1-8</b>
	<b>Window Color</b> <b>None, Color 1-8</b>
	 <b>Color options can also be set to Solid or Translucent.</b>

# Using the Applications Menu



To access the Applications Menu, follow these steps:

1. Display Menu



2. Highlight

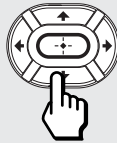

3. Press to select



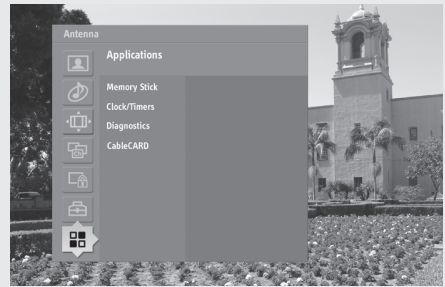

To change settings, press **↑ ↓ ← →**.  
Press **○** to confirm the selection.

To exit the Menu, press **MENU**.





## Selecting Applications Options



 You can also access the Memory Stick Viewer using the **F1** button on the remote control.



 You can also change the **Sleep** options using the **SLEEP** button on the remote control.

















The Applications Menu includes the following options:

Option	Description
Memory Stick	Displays the Memory Stick Viewer. For details, see page 67.
Clock/Timers	Select to set the clock, set the Sleep timer, and to program your TV to turn on and off at two scheduled viewing times.
Sleep	Set the time in minutes ( <b>15min, 30min, 45min, 60min, 90min, or Off</b> ) that you want the TV to remain on before shutting off automatically.
Timer 1 Timer 2	You can use the Timers to program the TV to turn on and off and tune to a specific channel at two scheduled viewing times.

 To go directly to programming Timer 1 or 2, press  instead of pressing .

 To return to the Timer Menu after programming one of the Timers, press  when the highlight is in the channel number field.

 To return to the Timer Menu after setting the **Current Time**, press  when the highlight is in the minute field.

Option	Description
	<b>Timer 1</b> and <b>Timer 2</b> are not available to be set until you set the <b>Current Time</b> .
<b>1</b>	Press  or  to highlight <b>Timer 1</b> or <b>Timer 2</b> . To set the timer, press  .
<b>2</b>	Press  or  to highlight one of the following options, then press  .
<b>Program</b>	Select to set the Timer by day, time, duration, and channel.
<b>Off</b>	Select to turn off the Timer. (Your previous settings are saved.)
<b>3</b>	If you selected <b>Program</b> in step 2, Press  and  to set the day(s), hour, minute, duration, and channel number. Press  or  to confirm each setting and move to the next setting. Press  to go back to the previous setting.
<b>4</b>	Press <b>MENU</b> to exit the Menu. An LED on the front panel will light, indicating the timer has been set.
<hr/>	
	<b>Current Time</b>
<b>1</b>	Press  to select <b>Current Time</b> .
<b>2</b>	Press  and  to set the current time (day, hour, and minute). Press  or  to confirm each setting and move to the next setting. Press  to go back to the previous setting.
<b>3</b>	Press <b>MENU</b> to exit the Menu.
<hr/>	
<b>Diagnostics</b>	Displays the strength of the terrestrial digital broadcast signal, to help you adjust your antenna to optimize signal reception.
<hr/>	
<b>CableCARD</b>	This list of selectable CableCARD options will vary, depending on your cable service provider.

# Other Information

## Overview

This chapter includes the following topics:

<i>Topic</i>	<i>Page</i>
Glossary	100
Contacting Sony	101
Troubleshooting	101
Specifications	107
Optional Accessories	108
Index	109

## Glossary

### analog signal

A signaling method that uses continuous changes in the amplitude or frequency of an electronic transmission to convey information.

### aspect ratio

Refers to the ratio between the width and height of the screen. This TV has a 16:9 (widescreen) aspect ratio, as opposed to a 4:3 aspect ratio.

#### 4:3 aspect ratio



#### 16:9 aspect ratio



### component video



Component video is sent through three cables: two color shade (chrominance) signals and one brightness (luminance) signal. Component video achieves greater color accuracy than composite video or S VIDEO by splitting chrominance into two separate portions.

### composite video



Composite video is sent through a single cable. Composite video combines the color shade (chrominance) and brightness (luminance) information into one video signal.

### digital television (DTV)

A new technology for transmitting and receiving broadcast television signals. DTV provides clearer resolution and improved sound quality over analog television.

### HDMI (High-Definition Multimedia Interface)

Provides an uncompressed, all-digital audio/video interface between this TV and any HDMI-equipped audio/video component, such as a set-top box, DVD player, and A/V receiver. HDMI supports enhanced, or high-definition video, plus two-channel digital audio.

### National Television System Committee (NTSC)

A unit of the Federal Communications Commission, Washington, DC, that establishes television standards in the United States, such as NTSC Color, the standard used in this TV.

### RF

Radio Frequency. That part of the frequency spectrum that is used to transmit TV and radio signals.

### S VIDEO



S VIDEO requires a single cable, which carries the brightness (luminance) and color (chrominance) signals of the picture separately. S VIDEO provides better resolution than composite video, which carries the signals together.

### VHF/UHF

VHF (Very High Frequency) is the part of the frequency spectrum from 30 to 300 megahertz. UHF (Ultra High Frequency) is the part of the frequency spectrum from 300 to 3,000 megahertz.

### 480i (SD)

Provides 480 lines of resolution. Displays images using interlaced scanning, which first transmits all the odd lines on the TV screen and then the even lines.

### 480p (SD)

Provides 480 lines of resolution. Displays images using progressive scanning, which transmits each line from top to bottom.

### 720p (HD)

Provides 720 lines of resolution. Displays images using progressive scanning, which transmits each line from top to bottom.

### 1080i (HD)

Provides 1080 lines of resolution. Displays images using interlaced scanning, which first transmits all the odd lines on the TV screen and then the even lines. 1080i is one of the formats used by HDTV (High Definition TV).

## Contacting Sony

If, after reading these operating instructions, you have additional questions related to the use of your Sony television, please call our Customer Information Services Center at 1-800-222-SONY (7669) (US residents only) or (416) 499-SONY (7669) (Canadian residents only).

Before calling Sony customer support, please write down the model and serial numbers of your TV. You'll find this information on the front cover of this manual.

## Troubleshooting

### Remote Control

Problem	Possible Remedies
Remote control does not operate	<ul style="list-style-type: none"> <li>❑ The batteries could be weak. Replace the batteries.</li> <li>❑ Check the orientation of the batteries.</li> <li>❑ Press the <b>TV FUNCTION</b> button. You may have inadvertently pressed the <b>SAT/CABLE FUNCTION</b> button, which changes the remote control to SAT or CABLE mode.</li> <li>❑ Make sure the TV's power cord is connected securely to the wall outlet.</li> <li>❑ Locate the TV at least 3-4 feet away from fluorescent lights.</li> </ul>
Cannot change channels with the remote control	<ul style="list-style-type: none"> <li>❑ If you are using the TV to change channels, first press the <b>TV FUNCTION</b> button.</li> <li>❑ If you are using another device to change channels, be sure you have not inadvertently switched your TV from the channel 3 or 4 setting. Use the <b>Channel Fix</b> option to "fix" the channel based on the hookup you used (see page 89).</li> <li>❑ If you are using another device to change channels, be sure to press the <b>FUNCTION</b> button for that device. For example, if you are using your cable box to change channels, be sure to press the <b>SAT/CABLE FUNCTION</b> button.</li> </ul>
Remote control does not operate non-Sony video equipment	<ul style="list-style-type: none"> <li>❑ If you replaced the batteries to the remote recently, the code numbers for the video equipment may need to be reset.</li> <li>❑ There may be more than one code for the equipment that you are attempting to operate.</li> <li>❑ There is a possibility that some non-Sony equipment cannot be operated by your Sony TV remote. You may need to use the equipment's original remote control.</li> </ul>

## Channels

<i>Problem</i>	<i>Possible Remedies</i>
Cannot receive upper channels (UHF) when using an antenna	<ul style="list-style-type: none"> <li>❑ Use <b>Auto Program</b> in the Channel Menu to add receivable channels that are not presently in the TV's memory (see page 89).</li> </ul>
TV is fixed to one channel	<ul style="list-style-type: none"> <li>❑ Use <b>Auto Program</b> in the Channel Menu to add receivable channels that are not presently in the TV's memory (see page 89).</li> <li>❑ Check your Channel Fix settings (see page 89).</li> </ul>
Cannot receive any channels when using cable TV	<ul style="list-style-type: none"> <li>❑ Use <b>Auto Program</b> in the Channel Menu to add receivable channels that are not presently in the TV's memory (see page 89).</li> </ul>
Cannot receive or select channels	<ul style="list-style-type: none"> <li>❑ Use <b>Auto Program</b> in the Channel Menu to add receivable TV channels that are not presently in TV memory (see page 89).</li> </ul>
Some digital cable channels are not being displayed	<ul style="list-style-type: none"> <li>❑ Certain cable TV companies have limitations on the broadcast of digital cable channels. Check with your cable TV company for more information.</li> <li>❑ Check with your cable TV company if the channels are scrambled or encrypted. You will need a CableCARD or a separate set-top box to view those channels.</li> <li>❑ Some optional digital cable broadcast formats may not be supported. If your cable TV company is broadcasting digital signals in unsupported broadcast formats, you will need a separate set-top box provided by your cable TV company to view those channels.</li> <li>❑ The digital cable channel may be set to <b>Hide</b> in the Channel Menu (see page 90).</li> <li>❑ Use the Digital Channels feature to search for new digital channels (see page 89).</li> </ul>





## CableCARD

<i>Problem</i>	<i>Possible Remedies</i>
Problems using CableCARD or CableCARD services	<ul style="list-style-type: none"> <li>❑ Check that the CableCARD is inserted properly (see pages 41-42).</li> <li>❑ The CableCARD must be activated by your local cable TV provider before you can receive digital cable TV services. See the activation instructions on pages 41-42.</li> <li>❑ Check the <b>Diagnostics</b> and <b>CableCARD</b> menu options (see page 98). (This can be useful in providing information to an authorized technician or repair person.)</li> <li>❑ Contact your cable TV company.</li> </ul>

## Memory Stick

Problem	Possible Remedies
Image does not display/Cannot see all files	<ul style="list-style-type: none"> <li><input type="checkbox"/> Make sure the image file is a JPEG (.jpg, .jpeg) file or an MPEG1 (.mpg, .mpeg) file.</li> <li><input type="checkbox"/> Make sure the Memory Stick is inserted properly (see page 70).</li> <li><input type="checkbox"/> Check the <b>Filter</b> option setting (see page 80).</li> <li><input type="checkbox"/> Check the <b>Select Folder</b> setting (see page 80) and ensure that files are either in DCF directories if <b>Digital Camera Folders</b> is selected (see page 80), or in the currently selected folder if <b>Select a Folder</b> is selected (see page 80).</li> <li><input type="checkbox"/> The maximum number of files the Memory Stick Viewer can display is 2,000 files total, including all JPEG, MPEG1, and MP3 files.</li> <li><input type="checkbox"/> If you are using a Memory Stick with the Memory Select function, try changing the position of the A/B select switch.</li> </ul>
JPEG image displays undesirable motion or flicker in full screen	<ul style="list-style-type: none"> <li><input type="checkbox"/> JPEGs captured using a digital video camera may appear to display motion in full screen. This is a result of the way digital video cameras record still images, and is not a result of a malfunction with the TV.</li> </ul>
Rotation not saved after Memory Stick is ejected or Memory Stick Viewer is closed	<ul style="list-style-type: none"> <li><input type="checkbox"/> The Memory Stick might be locked. Unlock the Memory Stick and try rotating the image again.</li> <li><input type="checkbox"/> The file might not have information (EXIF data) that is usually generated when a digital camera records a photo. In this case, it is not possible to save the rotation.</li> <li><input type="checkbox"/> There might be insufficient space on the Memory Stick to save the rotated file. Try deleting one or more files and rotating the image again.</li> </ul>
Cannot Rotate, Zoom, Pan or Print Mark MPEG files	<ul style="list-style-type: none"> <li><input type="checkbox"/> These functions are available only for JPEG files.</li> </ul>
Cannot show (or hide) file information in full screen or Slide Show	<ul style="list-style-type: none"> <li><input type="checkbox"/> Set the <b>File/Information</b> option to <b>On</b> or <b>Off</b> (see page 79).</li> </ul>
Cannot set print quantity	<ul style="list-style-type: none"> <li><input type="checkbox"/> The Memory Stick might be locked. Unlock the Memory Stick and try setting the print quantity again.</li> </ul>
Cannot see Menu	<ul style="list-style-type: none"> <li><input type="checkbox"/> Press <b>▲</b> to display the Menu again.</li> </ul>
Cannot hear audio while using Memory Stick	<ul style="list-style-type: none"> <li><input type="checkbox"/> Check the TV's volume or <b>Speaker</b> (page 87) settings.</li> <li><input type="checkbox"/> To hear JPEG voice memo in full screen view, select the <b>Digital Camera Folders</b> option and set the <b>Filter</b> option to <b>Show All</b>.</li> <li><input type="checkbox"/> Check that the <b>Music</b> option is not set to <b>Off</b> (see page 79).</li> </ul>
Not all MP3 files on Memory Stick are included when the <b>Music /Complete List</b> option is selected (page 79)	<ul style="list-style-type: none"> <li><input type="checkbox"/> The Memory Stick Viewer can display a maximum of 2,000 files total, including all JPEG, MPEG1, and MP3 files.</li> <li><input type="checkbox"/> Make sure that the file is named with the file extension (.mp3).</li> </ul>
Cannot see MP3 list to play music	<ul style="list-style-type: none"> <li><input type="checkbox"/> MP3 files on your Memory Stick only can be played as background music during a Slide Show (see page 79).</li> </ul>
MP3 file does not play back correctly	<ul style="list-style-type: none"> <li><input type="checkbox"/> The Memory Stick Viewer supports only MP3 files with a fixed data rate of 128 kbps (kilobits per second).</li> </ul>
MP3 files on the Memory Stick are not listed	<ul style="list-style-type: none"> <li><input type="checkbox"/> Only MP3 files that are named with the file extension (.mp3) are displayed in the list.</li> </ul>
Music files are playing in wrong order	<ul style="list-style-type: none"> <li><input type="checkbox"/> MP3 files are played in alphabetical order, according to the folder in which they are stored. If you want to change the playing order, rename your files alphabetically in the order in which you want them to play or create an MP3 playlist (.m3u file) on a PC.</li> </ul>



Problem	Possible Remedies
Print Marks (DPOF) set by the Memory Stick Viewer are not recognized by the DPOF-compatible photo printer.	❑ The DPOF Print Mark feature works only on photos containing EXIF data (data stored by the camera) that are located within the digital camera (DCF) folders (see “About DCF File Names” on page 81 for a description).
MPEG1 movie does not play back correctly	❑ Some variations of MPEG1 movies may not be compatible with the Memory Stick Viewer.
MPEG1 quality is poor when enlarged (page 77)	❑ The quality of the movie when enlarged depends on the resolution of the MPEG1 file. See your camera’s instruction manual for details.
Error message is displayed	❑ No Memory Stick There is no Memory Stick in the slot.
	❑ Memory Stick Locked The lock mechanism on the Memory Stick is engaged.
	❑ Memory Stick Error The Memory Stick in the slot might be damaged; try a different Memory Stick.
	❑ Format Error The Memory Stick may have been formatted using a PC or other device that is not compatible with cameras.
Error icon is displayed	 The file is not a valid MPEG1 or JPEG format, or it is a progressive JPEG (which is not supported).
	 The thumbnail is not DCF-compatible.
	 The file is a JPEG or an MPEG1, but the thumbnail is unreadable.
	 The file is unreadable.

## Audio

Problem	Possible Remedies
Good picture, no sound	<ul style="list-style-type: none"> <li>❑ Press <b>MUTING</b> so that the word <b>Muting</b> disappears from the screen (see page 48).</li> <li>❑ Make sure the <b>Speaker</b> option is set to <b>On</b> in the Audio Menu (see page 87).</li> <li>❑ Make sure the <b>MTS</b> option is set to <b>Stereo</b> or <b>Mono</b> (see page 86).</li> </ul>
Cannot gain enough volume when using a cable box	❑ Increase the volume of the cable box using the cable box’s remote control. Then press <b>TV FUNCTION</b> and adjust the TV’s volume.
Sound seems weak or insufficient	❑ The TV’s audio might be set to <b>Auto SAP</b> or <b>Mono</b> , when it might be better set to <b>Stereo</b> . In the Audio Menu (see page 86), set the <b>MTS</b> setting to <b>Stereo</b> . If already set to <b>Stereo</b> , switch to <b>Mono</b> (which may reduce background noise during weak stereo broadcasts).
Cannot raise the volume on external audio speakers	<ul style="list-style-type: none"> <li>❑ If the <b>Speaker</b> option is set to <b>Off</b> and the <b>Audio Out</b> option is set to <b>Fixed</b> (in order to output the sound to your audio system) use your audio receiver to adjust the sound (see page 86). Or, to use the TV remote control, set the <b>Audio Out</b> option to <b>Variable</b>.</li> <li>❑ To turn on the TV speakers, set the <b>Speaker</b> option to <b>On</b> (see page 86).</li> </ul>

## Video

Problem	Possible Remedies
No picture (screen not lit), no sound	<ul style="list-style-type: none"> <li>❑ If your TV does not turn on, and a red light keeps flashing, your TV may need service. Call your local Sony Service Center.</li> <li>❑ Make sure the power cord is plugged in.</li> <li>❑ Press the <b>POWER</b> button on the front of the TV.</li> <li>❑ Press the <b>TV/VIDEO</b> button to cycle through the connected video sources.</li> <li>❑ Try another channel; it could be station trouble.</li> </ul>
Dark, poor or no picture (screen lit), good sound	<ul style="list-style-type: none"> <li>❑ Adjust the <b>Picture</b> option in the Video Menu (see page 84).</li> <li>❑ Adjust the <b>Brightness</b> option in the Video Menu (see page 84).</li> <li>❑ Check the antenna/cable connections.</li> </ul>
No color	<ul style="list-style-type: none"> <li>❑ Adjust the <b>Color</b> option in the Video Menu (see page 84).</li> </ul>
Only snow and noise appear on the screen	<ul style="list-style-type: none"> <li>❑ Check the antenna/cable connections.</li> <li>❑ Try another channel; it could be station trouble.</li> <li>❑ Press <b>ANT</b> to change the input mode (see page 49).</li> </ul>
Dotted lines or stripes	<ul style="list-style-type: none"> <li>❑ Adjust the antenna.</li> <li>❑ Move the TV away from noise sources such as cars, neon signs, or hair-dryers.</li> </ul>
Double images or ghosts	<ul style="list-style-type: none"> <li>❑ Using a highly directional outdoor antenna or a cable may solve the problem.</li> </ul>
“Black box” on screen	<ul style="list-style-type: none"> <li>❑ You have selected a text option in the Setup Menu and no text is available. (See page 94 to reset Setup selections.) To turn off this feature, set the <b>Caption Vision</b> option to <b>Off</b>. If you were trying to select closed captioning, select <b>CC1</b> instead of <b>TEXT 1-4</b>.</li> </ul>
Bars appear at the top and bottom of the screen	<ul style="list-style-type: none"> <li>❑ Some wide-screen programs are filmed in aspect ratios that are greater than 16:9, such as 2.35:1. (This is especially common with theatrical releases). Your TV will show these programs with bars at the top and bottom of the screen. For more details, check the documentation that came with your DVD (or contact your program provider).</li> </ul>

## General

Problem	Possible Remedies
How to reset TV to factory settings	<ul style="list-style-type: none"> <li>❑ Turn on the TV. While holding down the <b>RESET</b> button on the remote control, press the <b>POWER</b> button on the TV. (The TV will turn itself off, then back on again.) Release the <b>RESET</b> button.</li> </ul>
How to restore Video settings to factory settings	<ul style="list-style-type: none"> <li>❑ Press the <b>RESET</b> button on the remote control while in the Video Menu (see page 84).</li> </ul>
How to restore Audio settings to factory settings	<ul style="list-style-type: none"> <li>❑ Press the <b>RESET</b> button on the remote control while in the Audio Menu (see page 86).</li> </ul>
Cannot cycle through the other video equipment connected to the TV	<ul style="list-style-type: none"> <li>❑ Be sure the <b>Label Video Inputs</b> option is not set to <b>Skip</b> (see page 95).</li> </ul>
Cannot operate Menu	<ul style="list-style-type: none"> <li>❑ If a Menu option appears in gray, this indicates that the TV is in a state in which the Menu option is not available.</li> </ul>
Lost password	<ul style="list-style-type: none"> <li>❑ In the password screen (see page 91), enter the following master password: <b>4357</b>. The master password clears your previous password; it cannot be used to temporarily unblock channels.</li> </ul>

<i>Problem</i>	<i>Possible Remedies</i>
TV makes “popping” sound when turned on	❑ This is a normal sound that results from the TV automatically degaussing each time it is turned on.
TIMER/STAND BY LED on front panel is lit	❑ The LED (see page 14) blinks when the TV is turned on, then shuts off when the picture is displayed. If the LED blinks for more than a minute, this may indicate the TV needs service. When lit, indicates that the timer is set (page 97). When the timer is set, this LED will remain lit even when the TV is turned off.
Digital cable box does not work	❑ If you are connecting a VCR and digital cable box using a splitter, as described on page 26, you must use a special bi-directional splitter that is designed to work with your digital cable box. Contact your cable TV company for details.
Cannot record digital channels to VCR	❑ Only analog channels can be recorded to your VCR.

## Specifications

Projection System	3 picture tubes, 3 lenses, horizontal in-line system	
Picture Tube	7-inch high-brightness monochrome tubes (6.3 raster size), with optical coupling and liquid cooling system	
Projection Lenses	High performance, large diameter hybrid lens F1.1	
Antenna	75 ohm external terminal for VHF/UHF	
Television System	NTSC	American TV Standard
	ATSC (8VSB terrestrial)	ATSC compliant 8VSB
	QAM on cable	ANSI/SCTE 07 2000
Channel Coverage	Terrestrial (analog)	2-69
	Cable TV (analog)	1-125
	Terrestrial (digital)	2-69
	Cable TV (digital)	1-135
Power Requirements	120V, 60 Hz	
Inputs/Outputs		
HDMI IN	Video	1080i, 720p, 480p, 480i
	Audio	Two channel linear PCM 32, 44.1 and 48 kHz, 16, 20 and 24 bit
Video (IN)	4 total (1 on front panel)	1 Vp-p, 75 ohms unbalanced, sync negative
S Video (IN)	3 total (1 on front panel)	Y: 1 Vp-p, 75 ohms unbalanced, sync negative
		C: 0.286 Vp-p (Burst signal), 75 ohms
Audio (IN)	7 total (1 on front panel)	500 mVrms (100% modulation)
		Impedance: 47 kilohm
Component Video Input	2 (Y, P <sub>B</sub> , P <sub>R</sub> )	Y: 1.0 Vp-p, 75 ohms unbalanced, sync negative;
		P <sub>B</sub> : 0.7 Vp-p, 75 ohms
		P <sub>R</sub> : 0.7 Vp-p, 75 ohms
CONTROL S (IN/OUT)	1	
Variable/Fixed Audio (OUT)	1	More than 408 mVrms at the maximum volume setting (Variable)
		More than 408 mVrms (Fixed)
		Impedance (output): 2 kilohms
Digital Audio Optical Output PCM/Dolby Digital	1	Optical Rectangular
CableCARD Slot	PCMCIA Type I/II	
Supplied Accessories	Remote Control	RM-Y915
	AA (R6) Batteries	2 supplied for remote control
Screen Size (measured diagonally)	KP-51WS655	51 inches
	KP-57WS655	57 inches
Speaker Output	20W x 2	
Dimensions (W x H x D)	KP-51WS655	1194 x 1280 x 666 mm (47 x 50 1/2 x 26 1/4 in)
	KP-57WS655	1326 x 1377 x 692 (52 1/4 x 54 1/4 x 27 1/4 in)
Mass	KP-51WS655	79.6 Kg (175.5 lbs)
	KP-57WS655	92.3 Kg (203.5 lbs)
Power Consumption	In Use	260 W
	In Standby	Under 1 W
	In CableCARD Standby	Under 16 W

Design and specifications are subject to change without notice.

## Optional Accessories

<i>Accessory</i>	<i>Description</i>	<i>Model Number</i>
Cables	Audio/Video	VMC-810/820/830 HG
	Audio	RKC-515HG
	Component Video	VMC-10/30 HG

# Index

0-9 buttons 48, 56, 62  
4:3 Default settings 88

## A

Advanced Video 85  
Alternate Audio 58  
Alternate Video 58  
ANT button 49, 56  
antenna, connecting 18  
Audio Menu 83  
Audio Out 87  
AUDIO OUT jack 16  
audio receiver, connecting 36  
Auto Program (channel setup)  
43, 89  
Auto SAP, MTS setting 86

## B

balance, adjusting 86  
bass, adjusting 86  
batteries, inserting in remote 47  
bilingual audio 86  
blocking programs. *See ratings.*  
brightness, adjusting 84  
Built 9

## C

cable  
connecting 18  
with VCR, connecting 24  
cable box  
connecting with VCR 26  
Twin View issues 61  
using with TV remote  
control 53  
CABLE jack, described 16  
CableCARD 9, 16, 17, 41  
CableCARD slot 16, 41, 42  
CableCARD, activating 41  
CableCARD, inserting card 41  
CableCARD, removing card 42  
Caption Vision 94  
carrying the TV 12  
CATV. *See cable*  
CH buttons 14, 49

changing picture size, in Twin  
View 63  
Channel Fix 89  
channel list, setting up 43  
Channel Menu 83  
Channel Skip/Add 90  
CineMotion 10, 85  
ClearEdge VM 85  
ClearEdge VM Velocity  
Modulation 10  
clearing, Favorite Channels 64  
closed caption modes 83, 94  
color, adjusting 84  
Component Video Inputs 10  
CONTROL S 40  
CONTROL S IN/OUT jacks,  
described 16  
Convergence 14, 95  
adjusting automatically 44  
adjusting manually 45  
convergence 95  
Cool, Color Temperature 84

## D

degauss 106  
DIGITAL AUDIO OPTICAL jack  
16  
digital channels, adding 89  
Digital Reality Creation 10  
DISPLAY button 49, 56  
DRC Mode 85  
DRC. *See Digital Reality Creation.*  
DVD Dream™ System 53  
DVD Five- and Mega-Disc  
Changers 53  
DVD HDD Combination 53  
DVD player  
using with TV remote  
control 53  
with A/V connectors,  
connecting 34  
DVD/VCR Combination 53  
DVD/VCR FUNCTION button  
48  
DVD/VCR POWER button 48

## E

Effect button 49  
ENT button 48, 56, 62  
ENTER button 56, 62  
error messages, Memory Stick  
104

## F

Fast-forward button 48  
Favorite Channels 10  
clearing 64  
in Channel Menu 89  
using 64  
FAVORITES button 49  
features 9  
Fixed audio setting 87  
Flash Focus 44, 95  
FLASH FOCUS button 14  
FREEZE button 48, 66  
Freeze, using 66  
Full 60  
Full (Screen Mode) 59, 60

## G

GUIDE button 48, 49, 57

## H

HD Detailer 10  
HD/DVD IN  
(1080i/720p/480p/480i)  
jacks, described 16  
High-Definition Multimedia  
Interface (HDMI) 10, 37, 38,  
100  
hue, adjusting 84

## I

Info Banner 94  
Infrared Receiver 14  
Initial Setup 43  
interlaced 10, 85, 100

## J

JUMP button 49, 56

**L**

Language, setting 95

**M**

Memory Stick

features 67

Index 72

indicator (LED) 14

inserting 70

insertion slot 14

panning photos 76

photo options 75

playing movies 77

precautions 82

removing 71

rotating photos 76

slide show options 79

troubleshooting 103

viewing photos 74

zooming photos 76

Memory Stick Viewer 10

MENU button 49, 56, 64, 83

Menus

Audio 83

Channel 83

Parent 83, 91

Setup 94

Video 83

Mono, MTS setting 86

Movie mode 84

movies

viewing thumbnails 72

MTS 86

MTS/SAP button 49

MUTING button 48, 56

**N**

Neutral, Color Temperature 84

Noise Reduction 85

Normal (Screen Mode) 59

**O**

off, turning off the TV 14

on, turning on the TV 14

**P**

Parent Menu 83, 91

parental control, described 10

password, changing 91

Pause button 48

photos

viewing thumbnails 72

picture contrast, adjusting 84

Picture in Picture. *See Twin View.*

PICTURE MODE button 48

Play button 48

POWER button 14

powering on/off, the TV 14

presetting channels 89

Pro (Video) mode 84

problems, troubleshooting 101–106

Program Guide 57

program guide 57

progressive 10, 85, 100

**R**

ratings, setting 91–93

ratings, viewing blocked

programs 92, 93

Record buttons 48

remote control

inserting batteries 47

programming 50–51

removing, Favorite Channels 64

RESET button 49, 64

resetting

Audio options 87

Video options 85

Rewind button 48

**S**

S VIDEO jack, described 13, 16

SAT/CABLE FUNCTION button 48

SAT/CABLE POWER button 49

satellite receiver, using with TV

remote control 52

Setup Menu 94

sharpness, adjusting 84

Simulated, Effect 86

sizing, picture in Twin View 63

SLEEP button 49

speakers

turning on/off 87

using external speakers 87

specifications 107

STAND BY indicator 14

Standard mode 84

Steady Sound, described 10

Steady Sound, setting 86

Stereo, MTS setting 86

Stop button 48

surround sound 86

**T**

TIMER indicator 106

TIMER LED 14

TOP MENU 48

transport buttons 48

treble, adjusting 86

troubleshooting 101–106

TruSurround 86

TruSurround, Effect 86

turning on/off the TV 14

TV FUNCTION button 49, 56

TV POWER button 49, 56

TV/SAT button 49

TV/VIDEO button 14, 49, 56

Twin View

button 48

described 10

using 61–63

**V**

Variable audio setting 87

VCR

using with TV remote

control 52

with cable box, connecting 26

with cable, connecting 24

with satellite receiver, connecting 30

Vertical Center 88

VHF/UHF jack, described 16

VIDEO (L/R)/AUDIO jacks, described 16

Video 2 access 13

Video Menu 83

Video modes, selecting 84

Vivid mode 84

VOL buttons 14, 48, 56

**W**

Warm, Color Temperature 84

Wide Mode 88

WIDE MODE button 48

Wide Zoom 59, 60

**Z**

Zoom (Screen Mode) 59, 60

zoom feature, with Twin View 63